

NO.	ECN NO.	DESCRIPTION	REV.	DRAW	DATE
1					
2					
3					

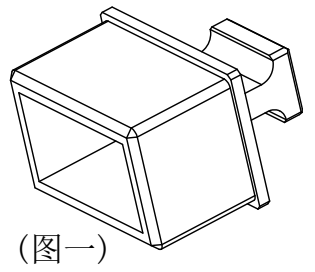

(图一)

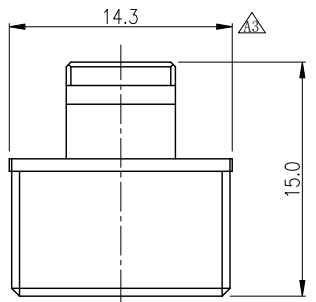
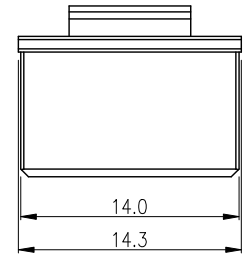

(图二)

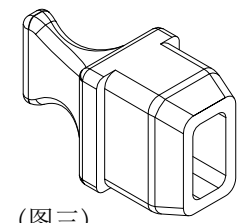
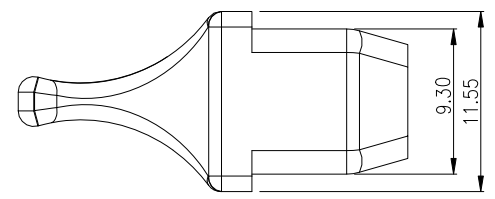
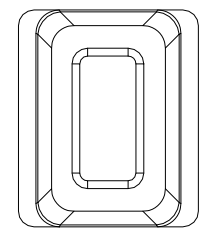
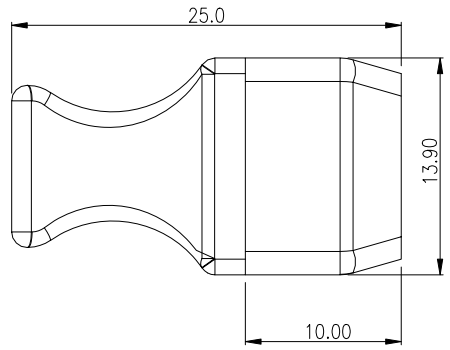
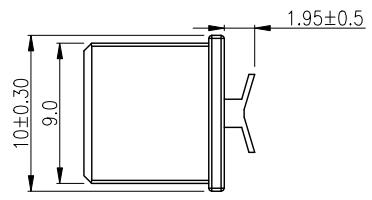
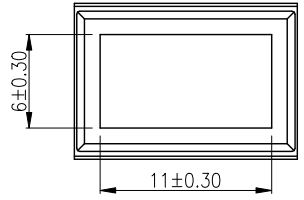
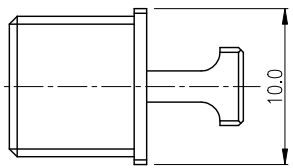
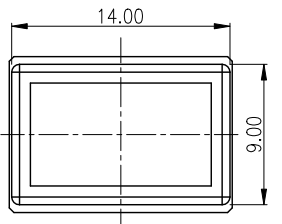
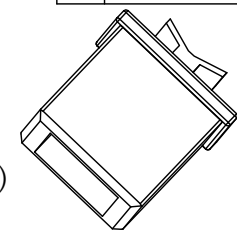

(图三)

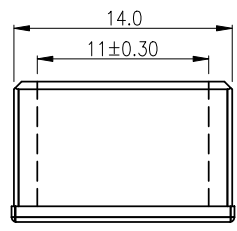

(图三)

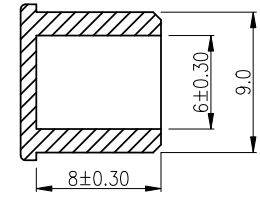
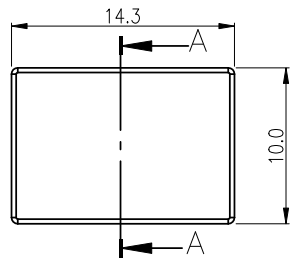
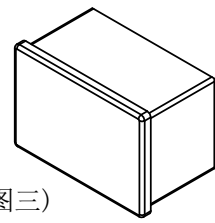

SECTION A-A

料号	品名	材质规格	图示规格
99040-000009	SFP 防尘帽	PE塑胶料 黑色	图一
99040-010009	SFP-00 防尘帽	PA66塑胶料 黑色 防火94V-2	
99040-020009	SFP-01 防尘帽	PE塑胶料 黑色	图二
99040-030009	SFP-02 防尘帽	PE塑胶料 黑色	图三
99040-040009	SFP-03 防尘帽	硅胶 黑色	图四

注：  
 1. 材质：见料号 RoSH  
 2. 外观毛边0.15Max, 无烧焦，无发白，无刮伤，明显收缩、裂纹、缺料、变形等缺陷。  
 3. 未注明R角为R0.2mm

产品客户图 Customer Drw		GLGNET® 深圳市方向电子股份有限公司			
未注公差 TOLERANCE UNLESS OTHERWISE SPECIFIED	X ±0.45 .X ±0.4 .XX ±0.3 X° ±3°	设计 DESIGN	HUGOULIANG	20220714	品名 TITLE SFP-XX 防尘帽
比例 SCALE	1:1	角法 PROJ.	设计 CHECKED		料号 ITEM NO. 99040-0X0009
张数 SHEET	1/1	大小 SIZE	A4	核准 APPROVED	图号 DWG NO. GLG-CPMFAR-053
单位 UNIT	mm	版本 REV.	A0		