

IGBT Modules

V_{CES}	1200V
I_c	15A

Applications

- Motor Drivers
- AC and DC Servo Drive Amplifier
- UPS (Uninterruptible Power Supplies)

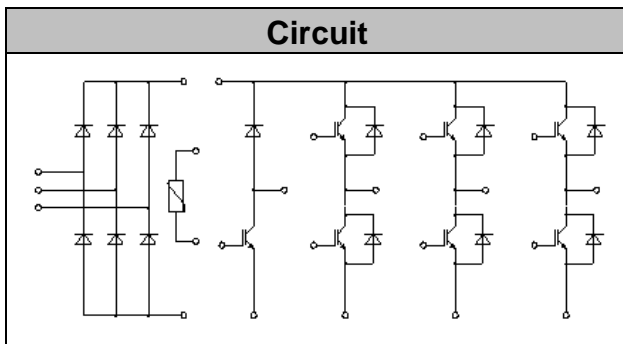

Features

- Low switching losses
- Low $V_{CE(sat)}$ with positive temperature coefficient
- Including fast & soft recovery anti-parallel FWD
- Low inductance case
- High short circuit capability(10us)
- Isolated heatsink using DBC technology
- Maximum junction temperature 175°C

● IGBT- inverter

Absolute Maximum Ratings

Parameter	Symbol	Conditions	Value	Unit
Collector-Emitter Voltage	V_{CES}	$V_{GE}=0V, I_c = 1mA, T_{vj}=25^{\circ}C$	1200	V
Continuous Collector Current	I_c	$T_C=100^{\circ}C, T_{vjmax}=175^{\circ}C$	15	A
Repetitive Peak Collector Current	I_{CRM}	$t_p=1ms$	30	A
Gate-Emitter Voltage	V_{GES}	$T_{vj}=25^{\circ}C$	± 20	V
Total Power Dissipation	P_{tot}	$T_C=25^{\circ}C$ $T_{vjmax}=175^{\circ}C$	155	W



● IGBT- inverter

Characteristic Values

Parameter	Symbol	Conditions	Value			Unit	
			Min.	Typ.	Max.		
Gate-Emitter Threshold Voltage	$V_{GE(th)}$	$V_{GE}=V_{CE}, I_C=0.5mA, T_{vj}=25^{\circ}C$	5.2	5.9	6.5	V	
Collector-Emitter Cut-off Current	I_{CES}	$V_{CE}=1200V, V_{GE}=0V, T_{vj}=25^{\circ}C$			1.0	mA	
Collector-Emitter Saturation Voltage	$V_{CE(sat)}$	$I_C=15A, V_{GE}=15V, T_{vj}=25^{\circ}C$		1.9		V	
		$I_C=15A, V_{GE}=15V, T_{vj}=125^{\circ}C$		2.1			
		$I_C=15A, V_{GE}=15V, T_{vj}=150^{\circ}C$		2.2			
Gate Charge	Q_G			0.15		uC	
Input Capacitance	C_{ies}	$V_{CE}=25V, V_{GE}=0V, f=1MHz, T_{vj}=25^{\circ}C$		0.98		nF	
Reverse Transfer Capacitance	C_{res}			0.034		nF	
Gate-Emitter leakage current	I_{GES}	$V_{CE}=0V, V_{GE}=20V, T_{vj}=25^{\circ}C$			400	nA	
Turn-on Delay Time	$t_{d(on)}$	$I_C=15A, V_{CE}=600V, V_{GE}=\pm 15V, R_G=39\Omega, T_{vj}=25^{\circ}C$		61		ns	
Rise Time	t_r			29		ns	
Turn-off Delay Time	$t_{d(off)}$			89		ns	
Fall Time	t_f			311		ns	
Energy Dissipation During Turn-on Time	E_{on}			1.98		mJ	
Energy Dissipation During Turn-off Time	E_{off}			0.99		mJ	
Turn-on Delay Time	$t_{d(on)}$		$I_C=15A, V_{CE}=600V, V_{GE}=\pm 15V, R_G=39\Omega, T_{vj}=150^{\circ}C$		60		ns
Rise Time	t_r				32		ns
Turn-off Delay Time	$t_{d(off)}$				89		ns
Fall Time	t_f				319		ns
Energy Dissipation During Turn-on Time	E_{on}			2.15		mJ	
Energy Dissipation During Turn-off Time	E_{off}			1.13		mJ	
SC Data	I_{sc}	$t_p \leq 10\mu s, V_{GE}=15V, T_{vj}=150^{\circ}C, V_{CC}=900V, V_{CEM} \leq 1200V$			55		A



● Diode-inverter

Absolute Maximum Ratings

Parameter	Symbol	Conditions	Value	Unit
Repetitive Peak Reverse Voltage	V_{RRM}	$T_{vj}=25^{\circ}\text{C}$	1200	V
Continuous DC Forward Current	I_F		15	A
Repetitive Peak Forward Current	I_{FRM}	$t_p=1\text{ms}$	30	A
I^2t -value	I^2t	$V_R=0\text{V}, t_p=10\text{ms}, T_{vj}=125^{\circ}\text{C}$	16.0	A ² s
		$V_R=0\text{V}, t_p=10\text{ms}, T_{vj}=150^{\circ}\text{C}$	14.0	

Characteristic Values

Parameter	Symbol	Conditions	Value			Unit
			Min.	Typ.	Max.	
Forward Voltage	V_F	$I_F=15\text{A}, T_{vj}=25^{\circ}\text{C}$		2.00		V
		$I_F=15\text{A}, T_{vj}=125^{\circ}\text{C}$		1.80		
		$I_F=15\text{A}, T_{vj}=150^{\circ}\text{C}$		1.75		
Recovered Charge	Q_{rr}	$I_F=15\text{A}$		0.45		uC
Peak Reverse Recovery Current	I_{rr}	$V_R=600\text{V}$ $-di_F/dt = 600\text{A/us}$		13		A
Reverse Recovery Energy	E_{rec}	$T_{vj}=25^{\circ}\text{C}$		0.49		mJ
Recovered Charge	Q_{rr}	$I_F=15\text{A}$		0.54		uC
Peak Reverse Recovery Current	I_{rr}	$V_R=600\text{V}$ $-di_F/dt = 600\text{A/us}$		14		A
Reverse Recovery Energy	E_{rec}	$T_{vj}=150^{\circ}\text{C}$		0.68		mJ



● IGBT-brake-chopper

Absolute Maximum Ratings

Parameter	Symbol	Conditions	Value	Unit
Collector-Emitter Voltage	V_{CES}	$V_{GE}=0V, I_C=1mA, T_{vj}=25^{\circ}C$	1200	V
Continuous Collector Current	I_C	$T_C=100^{\circ}C, T_{vjmax}=175^{\circ}C$	15	A
Repetitive Peak Collector Current	I_{CRM}	$t_p=1ms$	30	A
Gate-Emitter Voltage	V_{GES}	$T_{vj}=25^{\circ}C$	± 20	V
Total Power Dissipation	P_{tot}	$T_C=25^{\circ}C, T_{vjmax}=175^{\circ}C$	155	W

Characteristic Values

Parameter	Symbol	Conditions	Value			Unit	
			Min.	Typ.	Max.		
Gate-emitter Threshold Voltage	$V_{GE(th)}$	$V_{GE}=V_{CE}, I_C=0.5mA, T_{vj}=25^{\circ}C$	5.2	5.9	6.5	V	
Collector-Emitter Cut-off Current	I_{CES}	$V_{CE}=1200V, V_{GE}=0V, T_{vj}=25^{\circ}C$			1.0	mA	
Collector-Emitter Saturation Voltage	$V_{CE(sat)}$	$I_C=15A, V_{GE}=15V, T_{vj}=25^{\circ}C$		1.9		V	
		$I_C=15A, V_{GE}=15V, T_{vj}=125^{\circ}C$		2.1			
		$I_C=15A, V_{GE}=15V, T_{vj}=150^{\circ}C$		2.2			
Gate Charge	Q_G			0.09		uC	
Input Capacitance	C_{ies}	$V_{CE}=25V, V_{GE}=0V, f=1MHz, T_{vj}=25^{\circ}C$		0.98		nF	
Reverse Transfer Capacitance	C_{res}			0.034		nF	
Gate-Emitter leakage current	I_{GES}	$V_{CE}=0V, V_{GE}=20V, T_{vj}=25^{\circ}C$			400	nA	
Turn-on Delay Time	$t_{d(on)}$	$I_C=15A, V_{CE}=600V, V_{GE}=\pm 15V, R_G=39\Omega, T_{vj}=25^{\circ}C$		61		ns	
Rise Time	t_r			29		ns	
Turn-off Delay Time	$t_{d(off)}$			89		ns	
Fall Time	t_f			311		ns	
Energy Dissipation During Turn-on Time	E_{on}				1.98		mJ
Energy Dissipation During Turn-off Time	E_{off}				0.99		mJ



Turn-on Delay Time	$t_{d(on)}$	$I_C=15A$ $V_{CE}=600V$ $V_{GE}=\pm 15V$ $R_G=39\Omega$ $T_{vj}=150^\circ C$	60	ns
Rise Time	t_r		32	ns
Turn-off Delay Time	$t_{d(off)}$		89	ns
Fall Time	t_f		319	ns
Energy Dissipation During Turn-on Time	E_{on}		2.15	mJ
Energy Dissipation During Turn-off Time	E_{off}		1.13	mJ
SC Data	I_{SC}		$t_p \leq 10\mu s, V_{GE}=15V, T_{vj}=150^\circ C,$ $V_{CC}=900V, V_{CEM} \leq 1200V$	55

● Diode-brake-chopper

Absolute Maximum Ratings

Parameter	Symbol	Conditions	Value	Unit
Repetitive Peak Reverse Voltage	V_{RRM}	$T_{vj}=25^\circ C$	1200	V
Continuous DC Forward Current	I_F		10	A
Repetitive Peak Forward Current	I_{FRM}	$t_p=1ms$	20	A
I ² t-value	I^2t	$V_R=0V, t_p=10ms, T_{vj}=125^\circ C$	16.0	A ² s
		$V_R=0V, t_p=10ms, T_{vj}=150^\circ C$	14.0	

Characteristic Values

Parameter	Symbol	Conditions	Value			Unit
			Min.	Typ.	Max.	
Forward Voltage	V_F	$I_F=10A, T_{vj}=25^\circ C$		2.00		V
		$I_F=10A, T_{vj}=125^\circ C$		1.85		
		$I_F=10A, T_{vj}=150^\circ C$		1.80		
Recovered Charge	Q_{rr}	$I_F=10A$		0.26		uC
Peak Reverse Recovery Current	I_{rr}	$V_R=600V$ $-di_F/dt = 500A/\mu s$		11		A
Reverse Recovery Energy	E_{rec}	$T_{vj}=25^\circ C$		0.25		mJ
Recovered Charge	Q_{rr}	$I_F=10A$		0.49		uC
Peak Reverse Recovery Current	I_{rr}	$V_R=600V$ $-di_F/dt = 500A/\mu s$		13		A
Reverse Recovery Energy	E_{rec}	$T_{vj}=150^\circ C$		0.50		mJ



● Diode-rectifier

Absolute Maximum Ratings

Parameter	Symbol	Conditions	Value	Unit
Repetitive Peak Reverse Voltage	V_{RRM}	$T_{vj}=25^{\circ}C$	1600	V
Average output Current 50/60Hz, sine wave	$I_{F(AV)}$	$T_C=100^{\circ}C$	20	A
Maximum RMS Current at Rectifier Output	I_{RMSM}	$T_C=100^{\circ}C$	40	A
Surge Forward Current	I_{FSM}	$V_R=0V, t_p=10ms, T_{vj}=25^{\circ}C$	330	A
		$V_R=0V, t_p=10ms, T_{vj}=150^{\circ}C$	280	A
I ² t-value	I ² t	$V_R=0V, t_p=10ms, T_{vj}=25^{\circ}C$	520	A ² s
		$V_R=0V, t_p=10ms, T_{vj}=150^{\circ}C$	390	A ² s

Characteristic Values

Parameter	Symbol	Conditions	Value			Unit
			Min.	Typ.	Max.	
Diode Forward Voltage	V_F	$I_F=15A, T_{vj}=150^{\circ}C$		0.96		V
Reverse Current	I_R	$T_{vj}=150^{\circ}C, V_R=1600V$			1.0	mA

● NTC-thermistor

Characteristic Values

Parameter	Symbol	Conditions	Value			Unit
			Min.	Typ.	Max.	
Rated Resistance	R_{25}			5.0		k Ω
Deviation of R100	$\Delta R/R$	$T_C=100^{\circ}C, R_{100}=493.3\Omega$	-5		5	%
Power Dissipation	P_{25}				20.0	mW
B-value	$B_{25/50}$	$R_2=R_{25}\exp[B_{25/50}(1/T_2-1/(298.15 K))]$		3375		K



● Module Characteristics

$T_c=25^{\circ}\text{C}$ unless otherwise specified

Parameter	Symbol	Conditions	Value			Unit
			Min.	Typ.	Max.	
Isolation Voltage	V_{isol}	$t=1\text{min}, f=50\text{Hz}$	2500			V
Maximum Junction Temperature	T_{jmax}				175	$^{\circ}\text{C}$
Operating Junction Temperature	$T_{\text{vj op}}$		-40		150	$^{\circ}\text{C}$
Storage Temperature	T_{stg}		-40		125	$^{\circ}\text{C}$
Stray-inductance-module	L_{SCE}			30		nH
Module lead resistance, terminals-chip	$R_{\text{CC}'+\text{EE}'}$	$T_c=25^{\circ}\text{C}$, per switch		8.00		m Ω
	$R_{\text{AA}'+\text{CC}'}$			6.00		
Thermal Resistance Junction-to Case	$R_{\theta\text{JC}}$	per IGBT-inverter		0.95	1.05	K/W
		per Diode-inverter		1.30	1.45	
		per IGBT-brake-chopper		0.95	1.05	
		per Diode-chopper		1.75	1.90	
		per Diode-rectifier		1.03	1.13	
Thermal Resistance Case-to Sink	$R_{\theta\text{CS}}$	per IGBT-inverter		0.95		K/W
		per Diode-inverter		1.05		
		per IGBT-brake-chopper		0.95		
		per Diode-chopper		1.30		
		per Diode-rectifier		1.17		
		per Module		0.058		
Mounting Force Per Clamp	F		20		50	N
Weight of Module	G			25		g

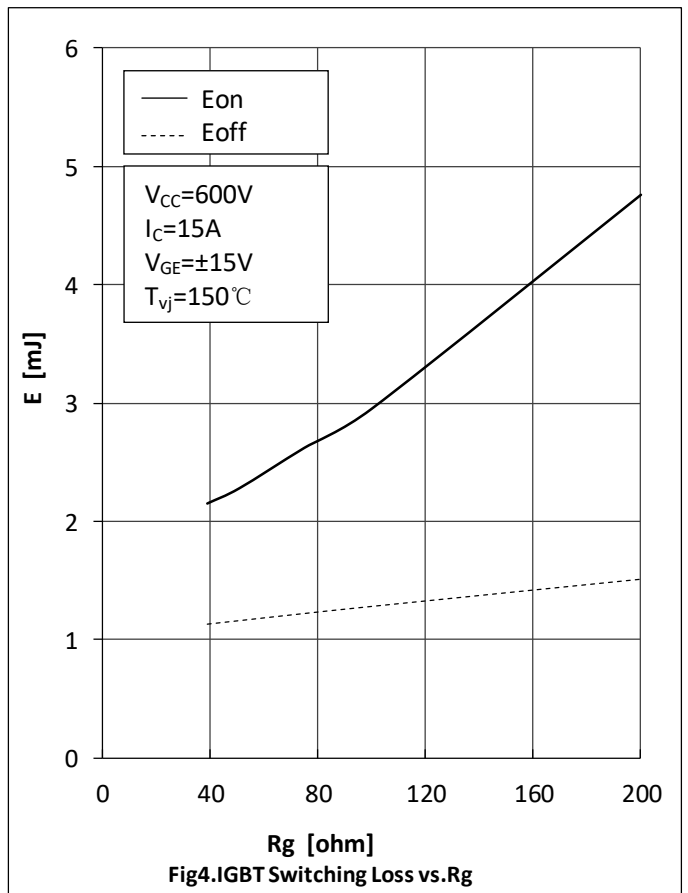
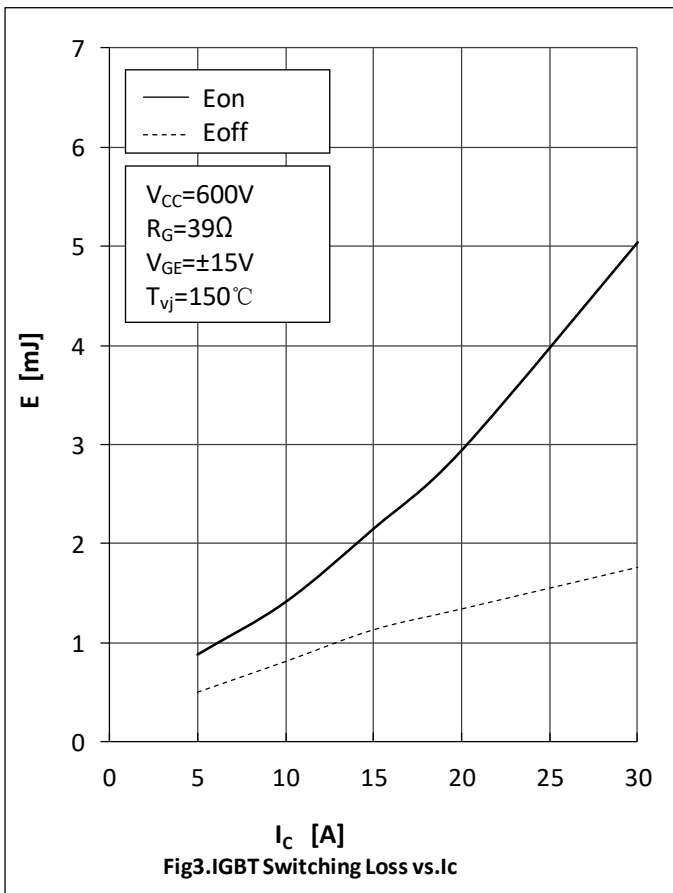
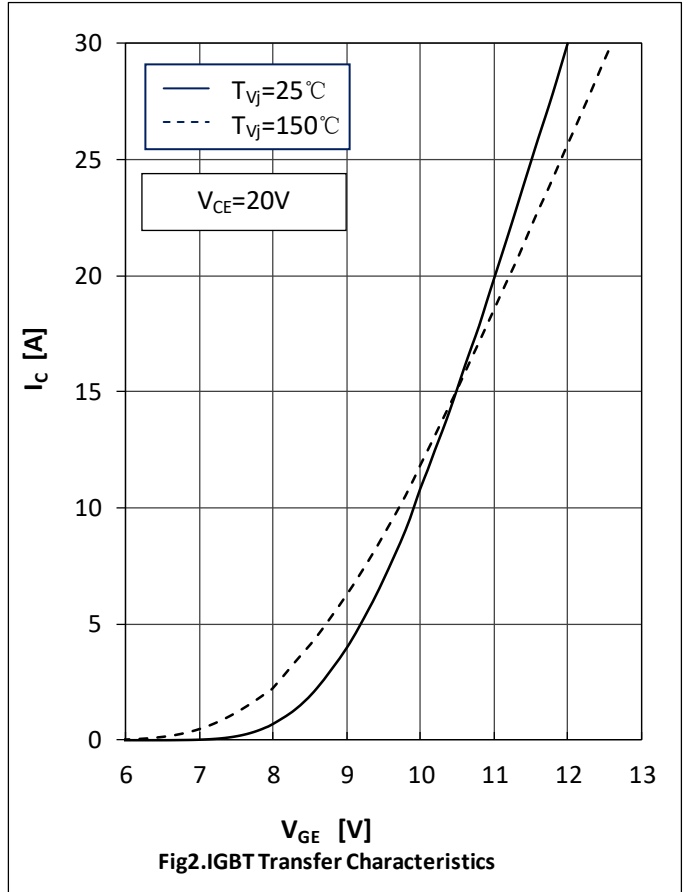
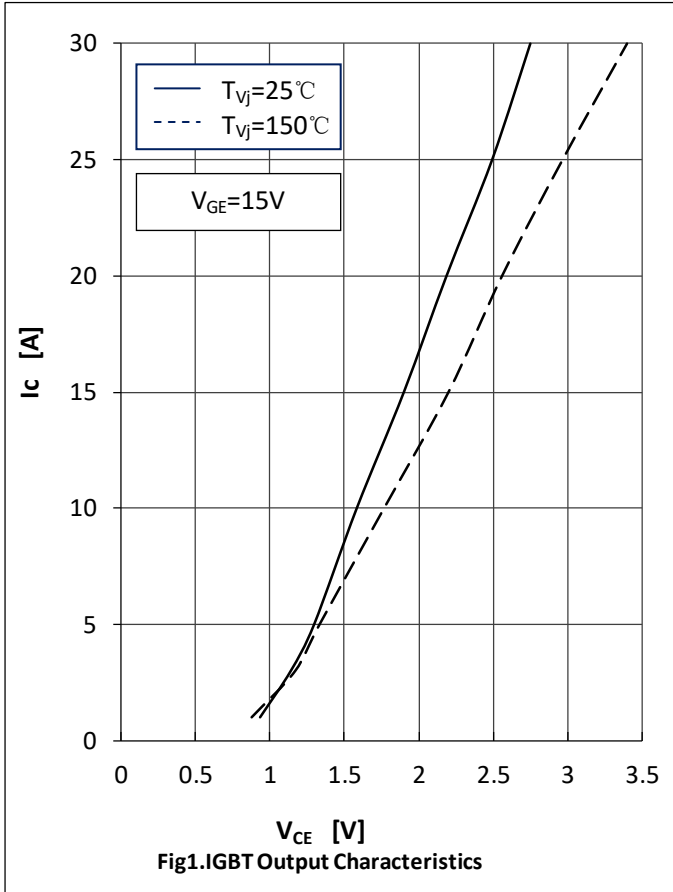

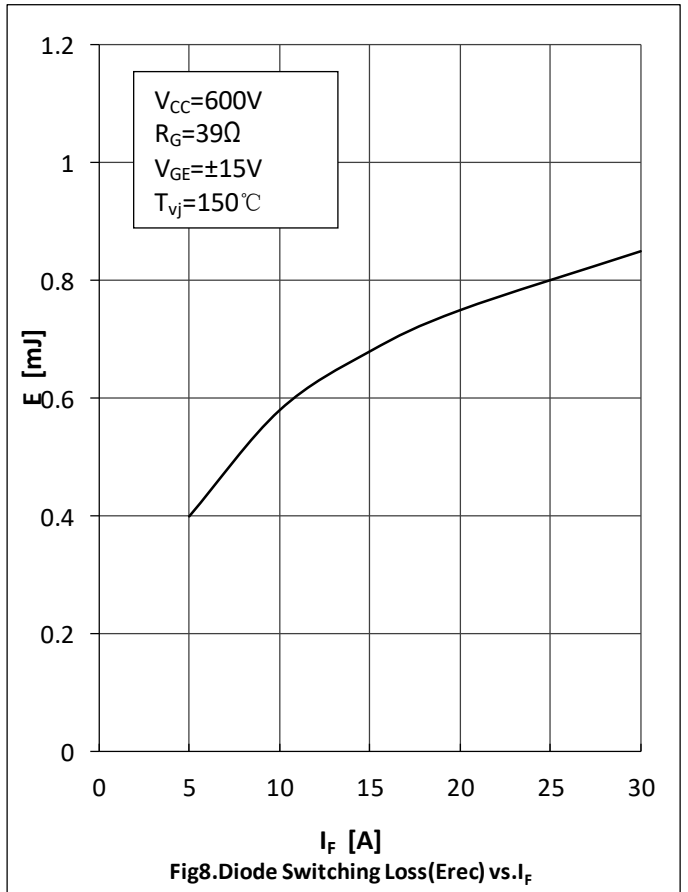
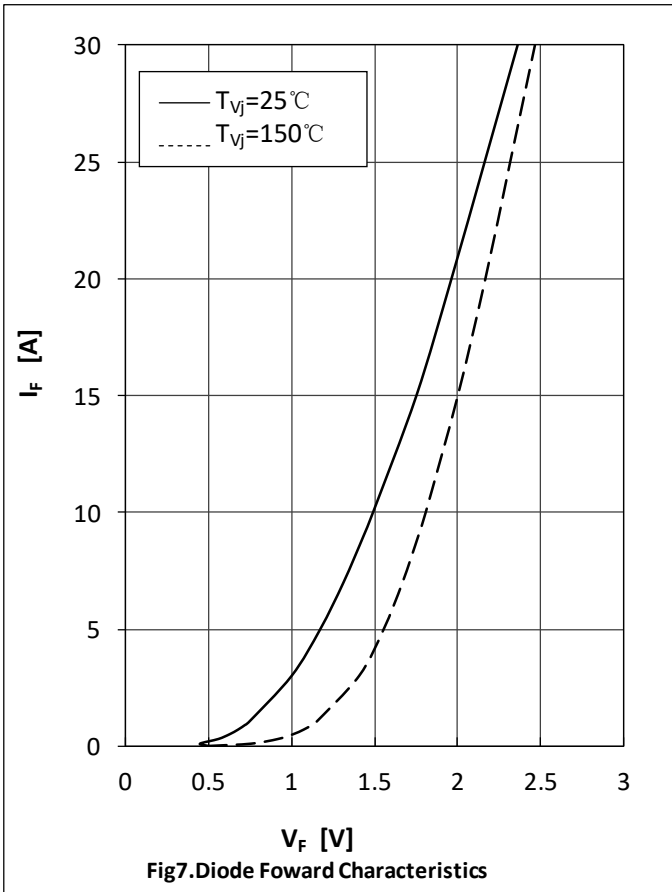
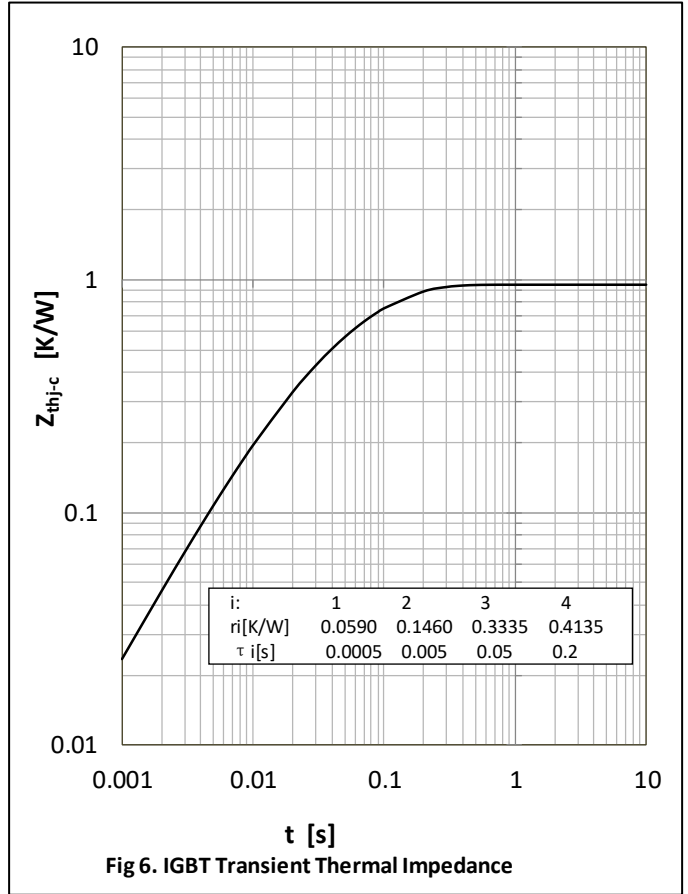
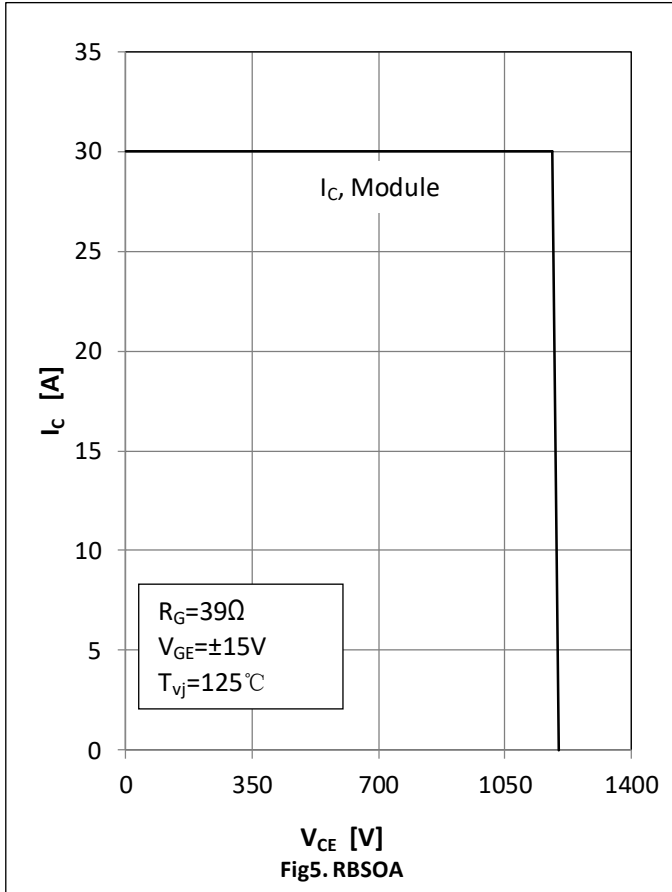

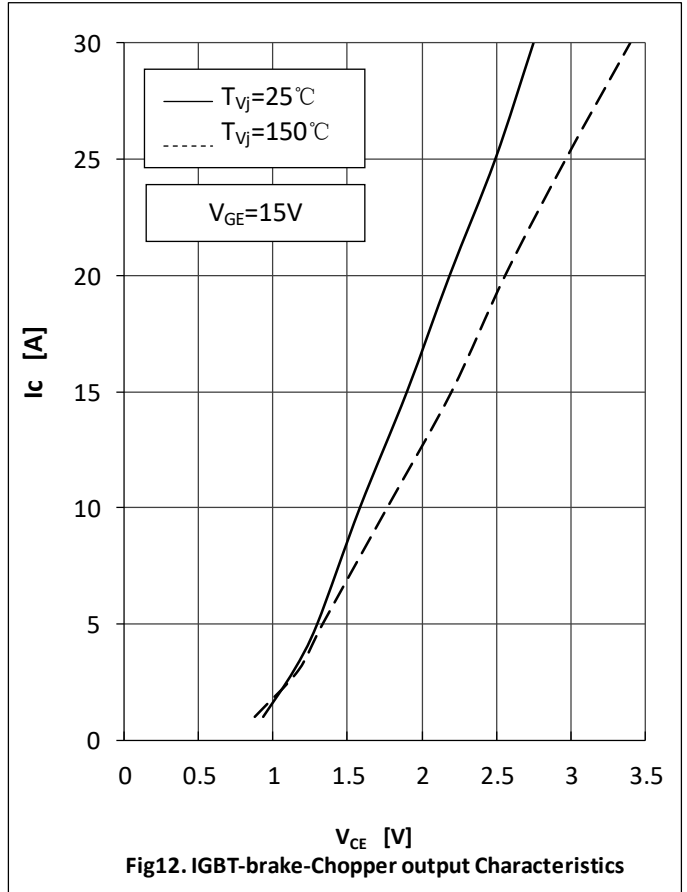
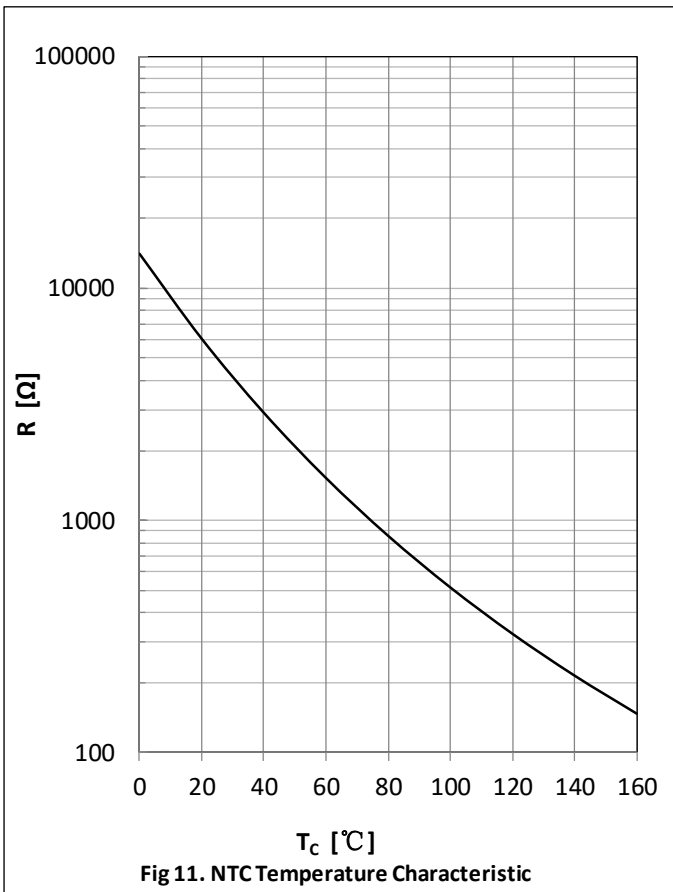
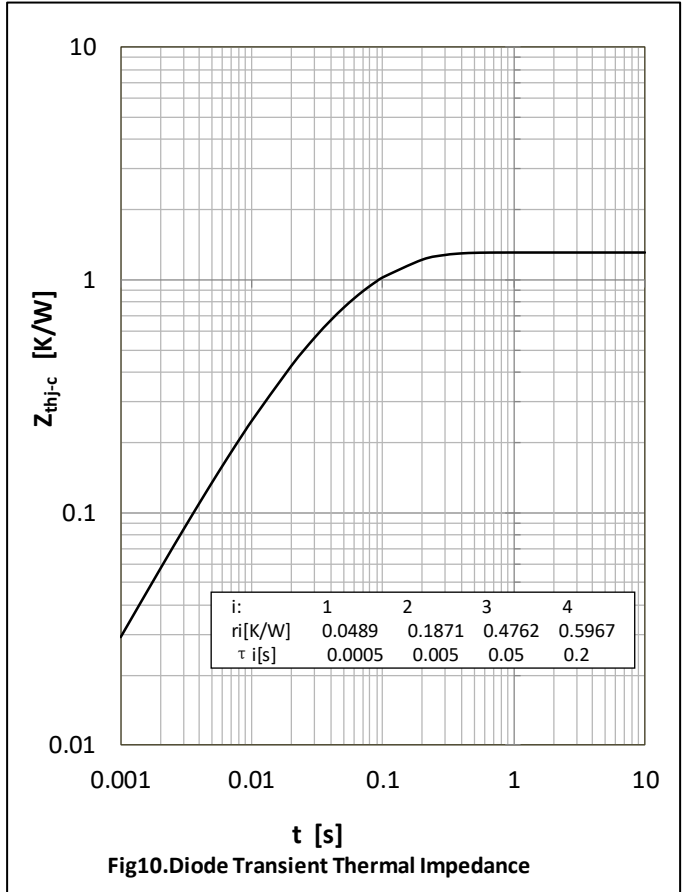
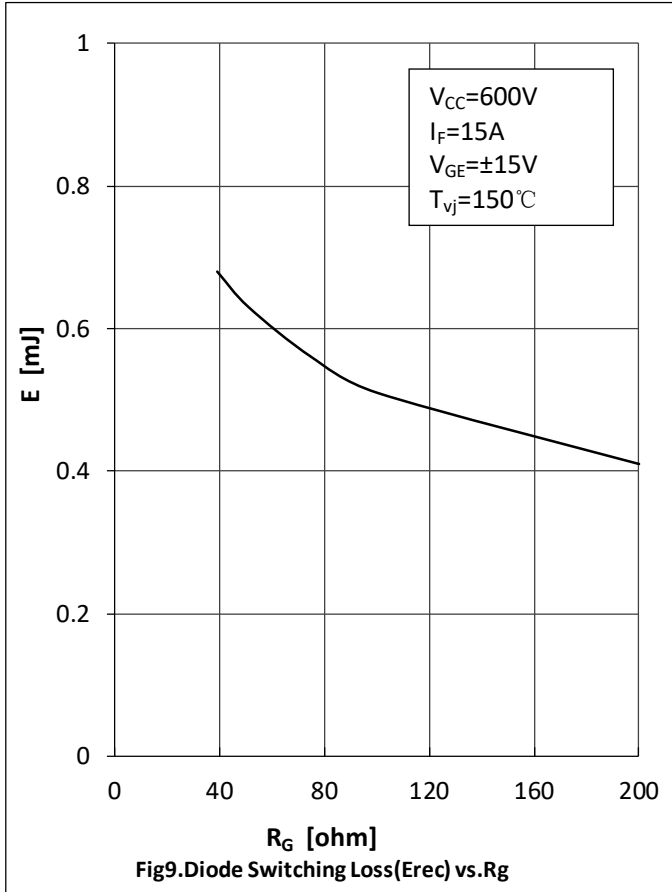

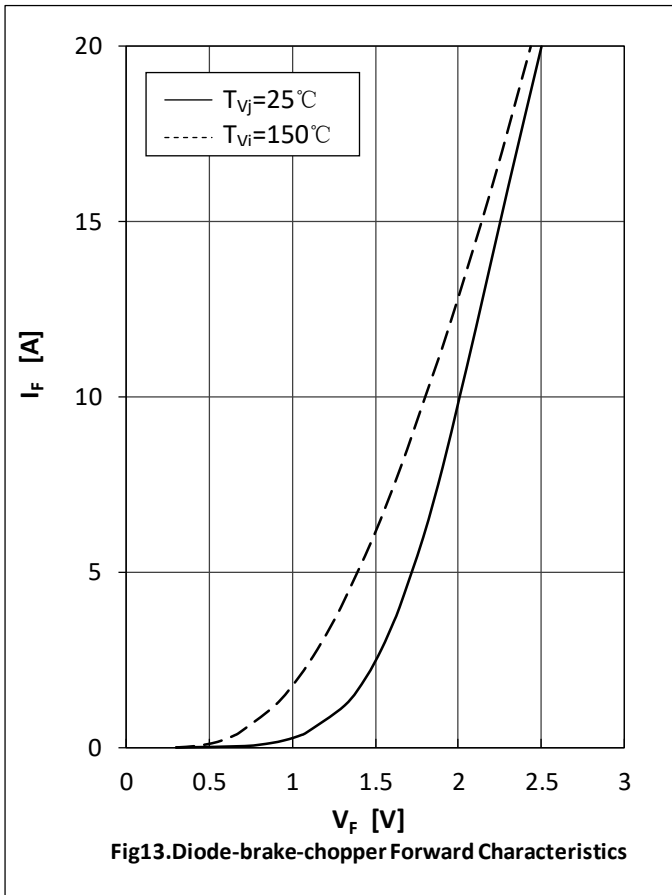



Circuit Diagram

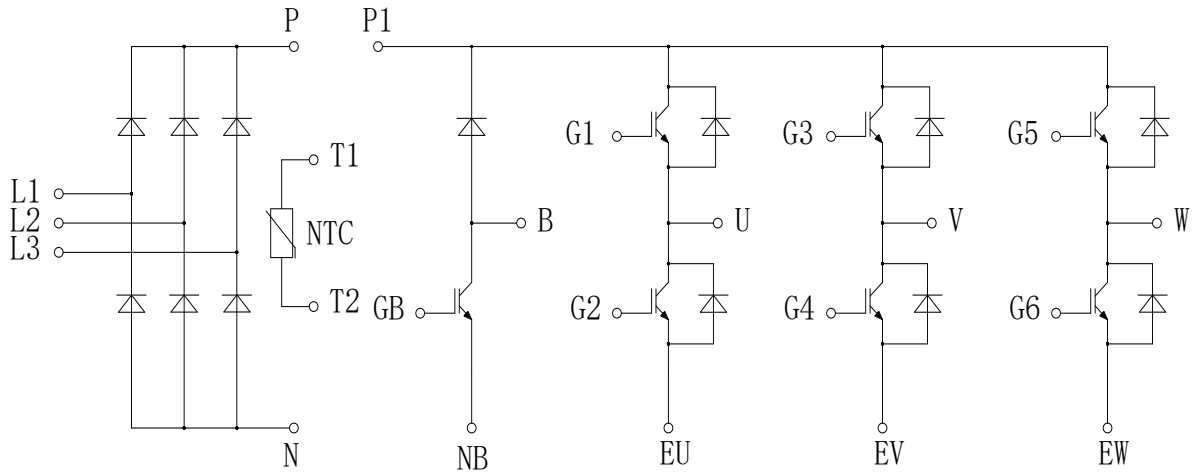

Package Dimensions

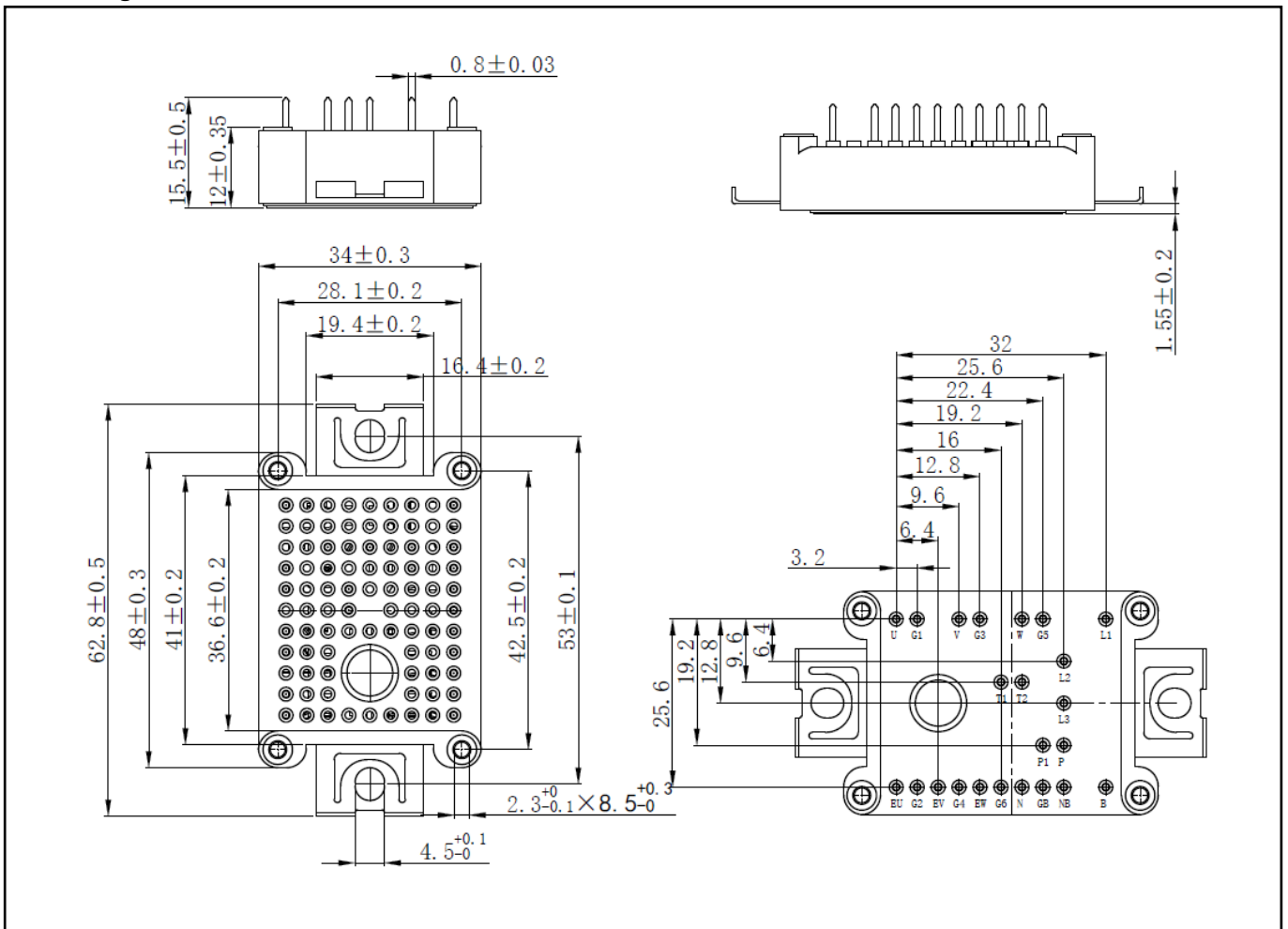



Disclaimer

The information presented in this document is for reference only. Yangzhou Yangjie Electronic Technology Co., Ltd. reserves the right to make changes without notice for the specification of the products displayed herein to improve reliability, function or design or otherwise.

The product listed herein is designed to be used with ordinary electronic equipment or devices, and not designed to be used with equipment or devices which require high level of reliability and the malfunction of with would directly endanger human life (such as aerospace machinery, nuclear-reactor controllers, fuel controllers and other safety devices), Yangjie or anyone on its behalf, assumes no responsibility or liability for any damages resulting from such improper use of sale.

This publication supersedes & replaces all information previously supplied. For additional information, please visit our website [http:// www.21yangjie.com](http://www.21yangjie.com) , or consult your nearest Yangjie's sales office for further assistance.