

NO.	ECN NO.	DESCRIPTION	REV.	DRAW	DATE
1.					
2.					
3.					

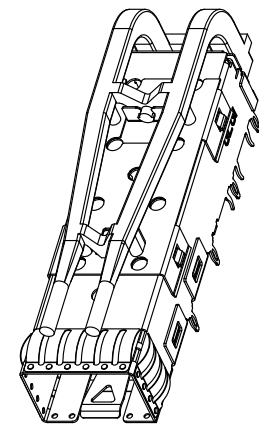
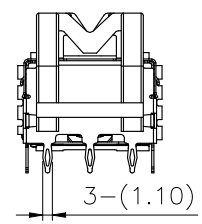
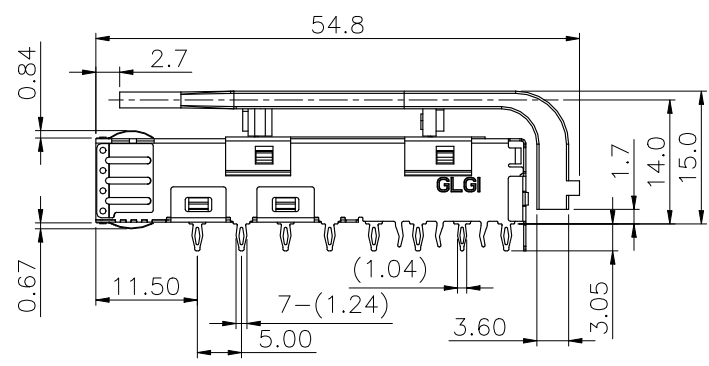
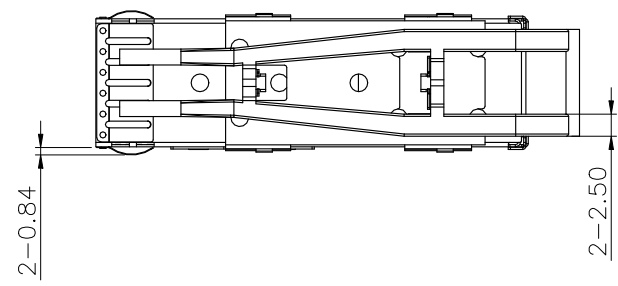
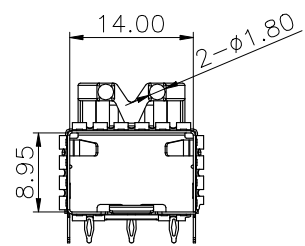

NOTES:
 1. CAGE: COPPER ALLOY
 2. CLIP: STAINLESS STEEL
 3. LIGHT PIPE: POLYCARBONATE COLOR CLEAR

产品客户图 Customer Drw		
未注公差	. X	±0.35
TOLERANCE	. XX	±0.25
UNLESS	. XXX	±0.15
OTHERWISE	X. °	±2°
SPECIFIED		

GLGNET® 深圳市方向电子股份有限公司
 SHEN ZHEN GLGNET ELECTRONICS CO.,LTD.

比例 SCALE	1:1	角法 PROJ.		设计 DESIGN		品名 TITLE	SFP+ 1x1-PF-G00 W-LPB
张数 SHEET	1/4	大小 SIZE	A4	校对 CHECKED		料号 ITEM NO.	160975-00131
单位 UNIT	mm	版本 REV.	A0	核准 APPROVED		图号 DWG NO.	GLG-160975

NO.	ECN NO.	DESCRIPTION	REV.	DRAW	DATE
1.					
2.					
3.					

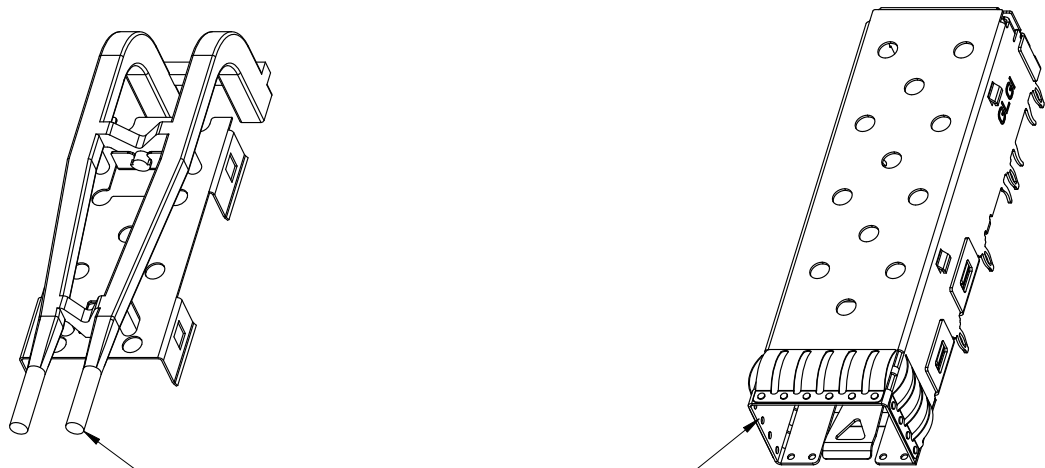

分两个部件包装放于同一纸箱

产品客户图 Customer Drw		
未注公差 TOLERANCE	. X	±0.35
UNLESS OTHERWISE SPECIFIED	. XX	±0.25
	. XXX	±0.15
	X. °	±2°

GLGNET® 深圳市方向电子股份有限公司
SHEN ZHEN GLGNET ELECTRONICS CO.,LTD.

比例 SCALE	1:1	角法 PROJ.		设计 DESIGN		品名 TITLE	SFP+ 1x1-PF-G00 W-LPB
张数 SHEET	2/4	大小 SIZE	A4	校对 CHECKED		料号 ITEM NO.	160975-00131
单位 UNIT	mm	版本 REV.	A0	核准 APPROVED		图号 DWG NO.	GLG-160975

NO.	ECN NO.	DESCRIPTION	REV.	DRAW	DATE
1.					
2.					
3.					

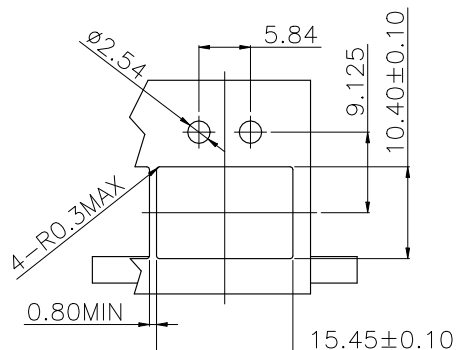

BEZEL
RECOMMENDED PANEL CUTOUT AND PC BOARD
PANEL POSITION AND THICKNESS 0.8-2.6

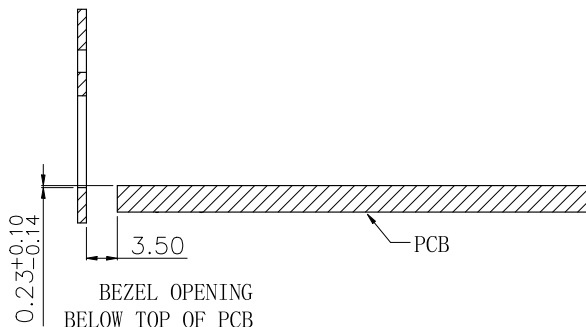

BEZEL OPENING
BELOW TOP OF PCB

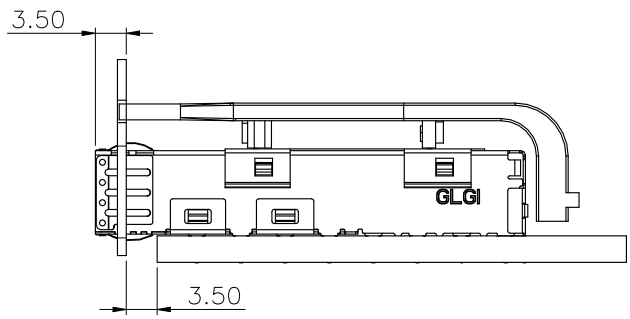
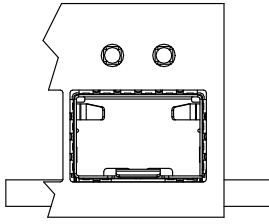

产品客户图 Customer Drw		
未注公差 TOLERANCE	. X	±0.35
UNLESS OTHERWISE SPECIFIED	. XX	±0.25
	. XXX	±0.15
	X. °	±2°

GLGNET® 深圳市方向电子股份有限公司
SHEN ZHEN GLGNET ELECTRONICS CO.,LTD.

比例 SCALE	1:1	角法 PROJ.	⊕	设计 DESIGN		品名 TITLE	SFP+ 1x1-PF-G00 W-LPB
张数 SHEET	3/4	大小 SIZE	A4	校对 CHECKED		料号 ITEM NO.	160975-00131
单位 UNIT	mm	版本 REV.	A0	核准 APPROVED		图号 DWG NO.	GLG-160975

NO.	ECN NO.	DESCRIPTION	REV.	DRAW	DATE
1.					
2.					
3.					

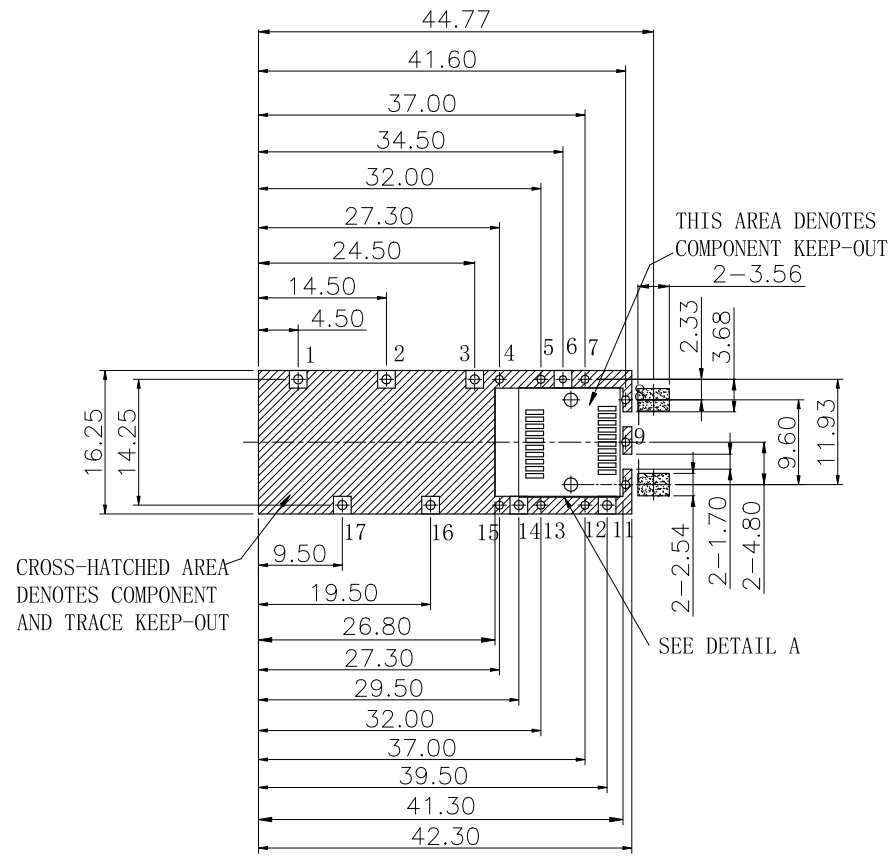

RECOMMENDED PCB LAYOUT (TOP VIEW)
(ALL TOLERANCES ARE ± 0.05)

NOTE:

- 1, 2, 3, 11, 14, 16, 17#孔直径为1.05mm;
- 4, 5, 7, 8, 9, 10, 12, 13, 15#孔直径为0.95mm;
- 6#孔直径为0.85mm;

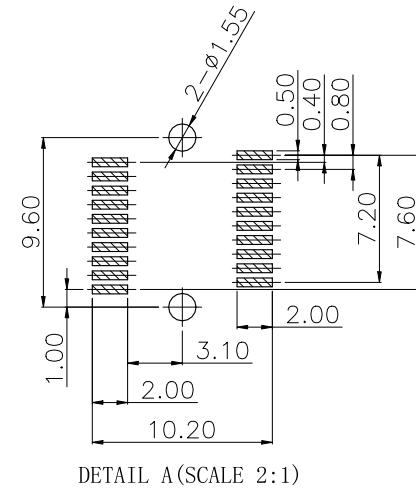

产品客户图 Customer Drw		GLGNET® 深圳市方向电子股份有限公司 SHEN ZHEN GLGNET ELECTRONICS CO.,LTD.				
未注公差 TOLERANCE UNLESS OTHERWISE SPECIFIED	.X .XX .XXX X.°	± 0.35 ± 0.25 ± 0.15 $\pm 2^\circ$	设计 DESIGN		品名 TITLE	SFP+ 1x1-PF-G00 W-LPB
比例 SCALE	1:1	角法 PROJ.	第一角法 FIRST ANGLE	设计 CHECKED	料号 ITEM NO.	160975-00131
张数 SHEET	4/4	大小 SIZE	A4	核准 APPROVED	图号 DWG NO.	GLG-160975