

# 规格承认书 SPECIFICATION

编号(No): .....  
日期(Date): .....

客户 (Customer): .....

品名(Product Name): **Chip Varistor for High Surge Current Suppression**

料号 (QAM Part Number) : QV0402~2220H Series

客户规格(Customer's Part Number): .....

客户承认 CUSTOMER CONFIRM			
承认章 STAMP	核准 APPROVE	审核 CHECK	经办人 SIGNATURE
			

## 1 外形尺寸和部件组成 Shape & Dimensions and Parts & Components

- 外形尺寸：见图 1 和表 1
- 部件组成：见图 2 和表 2



图 1 Fig.1



图 2 Fig.2

表 1 (Table 1)

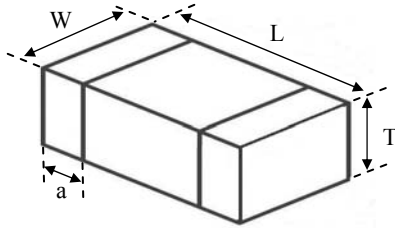
类型 Type	L (mm)	W (mm)	T (mm)	a (mm)
0402	1.0±0.10	0.5±0.10	0.5±0.10	0.25±0.15
0603	1.6±0.15	0.8±0.15	0.8±0.15	0.3±0.20
0805	2.0±0.20	1.25±0.20	0.85±0.20	0.5±0.30
1206	3.2 ±0.20	1.6 ±0.20	1.2 Max.	0.5±0.25
1210	3.2 ±0.30	2.5 ±0.25	1.5 Max.	0.5±0.25
1812	4.5 ±0.40	3.2 ±0.40	2.0 Max.	0.25~1.0
2220	5.7 ±0.40	5.0 ±0.40	2.5 Max.	0.25~1.0

表 2 (Table 2)

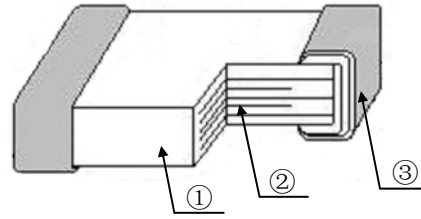
部分 Part	①	②	③
组成 Component	片式压敏电阻用 ZnO 半导体陶瓷 ZnO Semiconductor Ceramics for Chip Varistor	内电极 (Ag 或 Ag-Pd) Internal Electrode (Ag or Ag-Pd)	端电极 (Ag/Ni/Sn 三层) Terminal Electrode (Ag/Ni/Sn three layers)

## 2 产品标识 (料号) Product Identification(Part Number)

**QV**      **1206**      **H**      **380**      **K**      **T**  
 ①          ②          ③          ④          ⑤          ⑥

① 类别 Type	
QV	片式压敏电阻 Chip Varistor

② 外形尺寸 inch (mm) External Dimension L×W	
1206	0.12×0.06 (3.2×1.6)
1812	0.18×0.12 (4.5×3.2)

③ 应用代号 Application Code	
H	大浪涌电流抑制 High Surge Current Suppression

④ 最大直流工作电压 Maximum DC Operating Voltage	
090	9V
380	38V

⑤ 压敏电压公差 Tolerance of Varistor Voltage	
K	±10%
L	±15%

⑥ 包装 Packaging	
T	编带 Tape

## 3 电气特性 Electrical Characteristics

## I. QV0402H-QV0805H

型号 Part No.	最大工作电压 Max. Working Voltage		压敏电压 Varistor Voltage @1mA DC		最大限位电压 Max. Clamping Voltage (8/20 $\mu$ s 1A)	峰值电流 Peak Current (8/20 $\mu$ s)	能量耐量 Energy (10/1000 $\mu$ s)	参考电容 Typical Capacitance @1MHz
	V <sub>DC</sub> (V)	V <sub>AC</sub> (V)	V <sub>B</sub> (V)	$\Delta V_B$	V <sub>c</sub> (V)	I <sub>p</sub> (A)	W <sub>T</sub> (J)	C <sub>p</sub> (pF)
QV0402H5R5LT	5.5	4	12	$\pm 15\%$	24	20	0.05	150
QV0402H080LT	8	6	13	$\pm 15\%$	26	20	0.05	130
QV0402H120LT	12	9	18	$\pm 15\%$	30	20	0.05	80
QV0402H180KT	18	14	25	$\pm 10\%$	42	20	0.05	60
QV0402H260KT	26	20	36	$\pm 10\%$	60	20	0.05	50
QV0603H5R5LT	5.5	4	12	$\pm 15\%$	24	30	0.1	250
QV0603H080LT	8	6	13	$\pm 15\%$	26	30	0.1	230
QV0603H120LT	12	9	18	$\pm 15\%$	30	30	0.1	140
QV0603H140LT	14	11	20	$\pm 15\%$	34	30	0.1	130
QV0603H180KT	18	14	25	$\pm 10\%$	42	30	0.1	110
QV0603H260KT	26	20	36	$\pm 10\%$	60	30	0.1	80
QV0603H300KT	30	25	42	$\pm 10\%$	70	30	0.1	70
QV0603H380KT	38	30	51	$\pm 10\%$	85	30	0.1	60
QV0805H080LT	8	6	13	$\pm 15\%$	26	100	0.3	560
QV0805H120LT	12	9	18	$\pm 15\%$	30	100	0.3	360
QV0805H140LT	14	11	20	$\pm 15\%$	34	100	0.3	350
QV0805H180KT	18	14	25	$\pm 10\%$	42	100	0.3	280
QV0805H220KT	22	17	30	$\pm 10\%$	50	100	0.3	240
QV0805H260KT	26	20	36	$\pm 10\%$	60	100	0.3	210
QV0805H300KT	30	25	42	$\pm 10\%$	70	100	0.3	190
QV0805H330KT	33	26	45	$\pm 10\%$	75	100	0.3	180
QV0805H380KT	38	30	51	$\pm 10\%$	85	100	0.3	150
QV0805H450KT	45	35	59	$\pm 10\%$	100	100	0.3	130

## II. QV1206H

型号 Part No.	最大工作电压 Max. Working Voltage		压敏电压 Varistor Voltage @1mA DC		最大限位电压 Max. Clamping Voltage (8/20 $\mu$ s)		峰值电流 Peak Current (8/20 $\mu$ s)	能量耐量 Energy (10/1000 $\mu$ s)
	V <sub>DC</sub> (V)	V <sub>AC</sub> (V)	V <sub>B</sub> (V)	$\Delta V_B$	V <sub>c</sub> (V)	I <sub>c</sub> (A)	I <sub>p</sub> (A)	W <sub>T</sub> (J)
QV1206H090LT	9	7	13	$\pm 15\%$	24	1	200	0.5
QV1206H120LT	12	9	18	$\pm 15\%$	30	1	200	0.5
QV1206H140KT	14	11	20	$\pm 10\%$	34	1	200	0.5
QV1206H180KT	18	14	25	$\pm 10\%$	42	1	200	0.5
QV1206H220KT	22	17	30	$\pm 10\%$	50	1	200	0.5
QV1206H260KT	26	20	36	$\pm 10\%$	60	1	200	0.6
QV1206H300KT	30	25	41	$\pm 10\%$	70	1	200	0.6
QV1206H330KT	33	26	44	$\pm 10\%$	75	1	200	0.6
QV1206H380KT	38	30	50	$\pm 10\%$	85	1	200	0.6
QV1206H420KT	42	33	55	$\pm 10\%$	95	1	200	0.6
QV1206H450KT	45	35	59	$\pm 10\%$	100	1	200	0.6
QV1206H480KT	48	37	62	$\pm 10\%$	106	1	200	0.6
QV1206H560KT	56	40	72	$\pm 10\%$	118	1	200	0.6
QV1206H600KT	60	45	76	$\pm 10\%$	131	1	200	0.6
QV1206H650KT	65	50	82	$\pm 10\%$	142	1	200	0.6
QV1206H750KT	75	55	94	$\pm 10\%$	160	1	200	0.6
QV1206H850KT	85	60	100	$\pm 10\%$	175	1	200	0.6

## III. QV1210H\*\*\*

型号 Part No.	最大工作电压 Max. Working Voltage		压敏电压 Varistor Voltage @1mA DC		最大限位电压 Max. Clamping Voltage (8/20 $\mu$ s)		峰值电流 Peak Current (8/20 $\mu$ s)	能量耐量 Energy (10/1000 $\mu$ s)
	V <sub>DC</sub> (V)	V <sub>AC</sub> (V)	V <sub>B</sub> (V)	$\Delta V_B$	V <sub>c</sub> (V)	I <sub>c</sub> (A)	I <sub>p</sub> (A)	W <sub>T</sub> (J)
QV1210H090LT	9	7	13	$\pm 15\%$	24	2.5	400	1.5
QV1210H120LT	12	9	18	$\pm 15\%$	30	2.5	400	1.5
QV1210H140KT	14	11	20	$\pm 10\%$	34	2.5	400	1.5
QV1210H180KT	18	14	25	$\pm 10\%$	42	2.5	400	1.5
QV1210H220KT	22	17	30	$\pm 10\%$	50	2.5	400	1.5
QV1210H260KT	26	20	36	$\pm 10\%$	60	2.5	400	1.5
QV1210H300KT	30	25	41	$\pm 10\%$	70	2.5	400	1.5
QV1210H330KT	33	26	44	$\pm 10\%$	75	2.5	400	1.5
QV1210H380KT	38	30	50	$\pm 10\%$	85	2.5	400	1.5
QV1210H420KT	42	33	55	$\pm 10\%$	95	2.5	400	1.5
QV1210H450KT	45	35	59	$\pm 10\%$	100	2.5	400	1.5
QV1210H480KT	48	37	62	$\pm 10\%$	106	2.5	400	1.5
QV1210H560KT	56	40	72	$\pm 10\%$	118	2.5	400	1.5
QV1210H600KT	60	45	76	$\pm 10\%$	131	2.5	400	1.5
QV1210H650KT	65	50	82	$\pm 10\%$	142	2.5	400	1.5
QV1210H750KT	75	55	94	$\pm 10\%$	160	2.5	400	1.5
QV1210H850KT	85	60	100	$\pm 10\%$	175	2.5	400	1.5

## IV. QV1812H\*\*\*

型号 Part No.	最大工作电压 Max. Working Voltage		压敏电压 Varistor Voltage @1mA DC		最大限位电压 Max. Clamping Voltage (8/20 $\mu$ s)		峰值电流 Peak Current (8/20 $\mu$ s)	能量耐量 Energy (10/1000 $\mu$ s)
	V <sub>DC</sub> (V)	V <sub>AC</sub> (V)	V <sub>B</sub> (V)	$\Delta V_B$	V <sub>c</sub> (V)	I <sub>c</sub> (A)	I <sub>p</sub> (A)	W <sub>T</sub> (J)
QV1812H090LT	9	7	13	$\pm 15\%$	24	5.0	800	2.5
QV1812H120LT	12	9	18	$\pm 15\%$	30	5.0	800	2.5
QV1812H140KT	14	11	20	$\pm 10\%$	34	5.0	800	2.5
QV1812H180KT	18	14	25	$\pm 10\%$	42	5.0	800	3.0
QV1812H220KT	22	17	30	$\pm 10\%$	50	5.0	800	3.0
QV1812H260KT	26	20	36	$\pm 10\%$	60	5.0	800	3.0
QV1812H300KT	30	25	41	$\pm 10\%$	70	5.0	800	3.5
QV1812H330KT	33	26	44	$\pm 10\%$	75	5.0	800	3.5
QV1812H380KT	38	30	50	$\pm 10\%$	85	5.0	800	3.5
QV1812H420KT	42	33	55	$\pm 10\%$	95	5.0	800	3.5
QV1812H450KT	45	35	59	$\pm 10\%$	100	5.0	800	3.5
QV1812H480KT	48	37	62	$\pm 10\%$	106	5.0	800	3.5
QV1812H560KT	56	40	72	$\pm 10\%$	118	5.0	800	3.5
QV1812H600KT	60	45	76	$\pm 10\%$	131	5.0	800	3.5
QV1812H650KT	65	50	82	$\pm 10\%$	142	5.0	800	3.5
QV1812H750KT	75	55	94	$\pm 10\%$	160	5.0	800	3.5
QV1812H850KT	85	60	100	$\pm 10\%$	175	5.0	800	3.5

## V. QV2220H\*\*\*

型号 Part No.	最大工作电压 Max. Working Voltage		压敏电压 Varistor Voltage @1mA DC		最大限位电压 Max. Clamping Voltage (8/20 $\mu$ s)		峰值电流 Peak Current (8/20 $\mu$ s)	能量耐量 Energy (10/1000 $\mu$ s)
	V <sub>DC</sub> (V)	V <sub>AC</sub> (V)	V <sub>B</sub> (V)	$\Delta V_B$	V <sub>c</sub> (V)	I <sub>c</sub> (A)	I <sub>p</sub> (A)	W <sub>T</sub> (J)
QV2220H260KT	26	20	36	± 10%	60	5.0	1200	5.0
QV2220H300KT	30	25	41	± 10%	70	5.0	1200	5.0
QV2220H330KT	33	26	44	± 10%	75	5.0	1200	5.0
QV2220H380KT	38	30	50	± 10%	85	5.0	1200	5.0
QV2220H420KT	42	33	55	± 10%	95	5.0	1200	5.0
QV2220H450KT	45	35	59	± 10%	100	5.0	1200	5.0
QV2220H480KT	48	37	62	± 10%	106	5.0	1200	5.0
QV2220H560KT	56	40	72	± 10%	118	5.0	1200	5.0
QV2220H600KT	60	45	76	± 10%	131	5.0	1200	5.0
QV2220H650KT	65	50	82	± 10%	142	5.0	1200	5.0
QV2220H750KT	75	55	94	± 10%	160	5.0	1200	5.0
QV2220H850KT	85	60	100	± 10%	175	5.0	1200	5.0

V/I 特性曲线 V/I Characteristic Curves

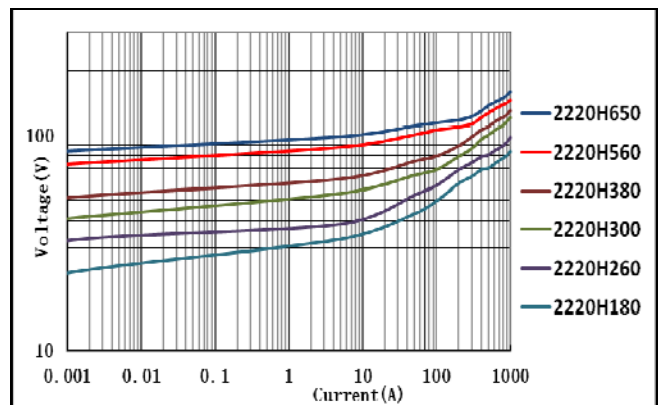
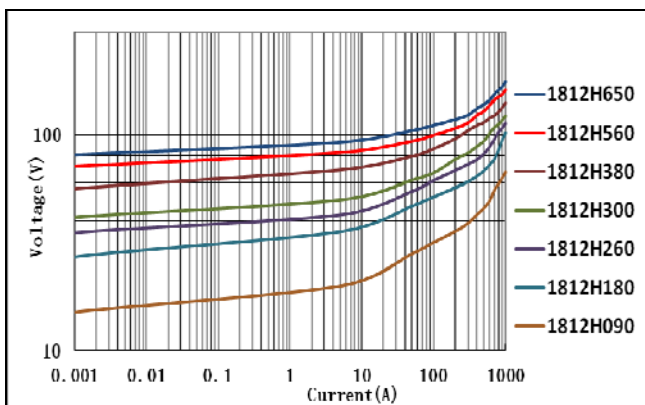
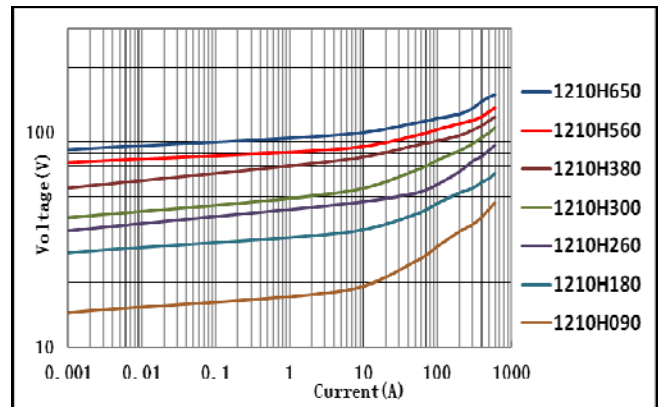
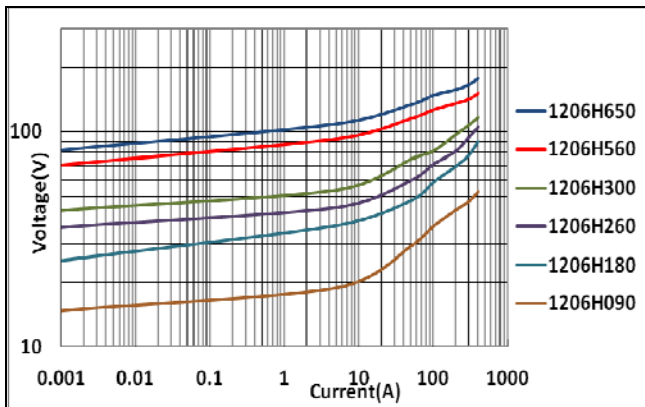

#### 4 检验和测试程序

##### • 测试条件

如无特别规定，检验和测试的标准大气环境条件如下：

- 环境温度：20±15℃；
- 相对湿度：65±20%；
- 气压：86 kPa~106 kPa

如果对测试结果有异议，则在下述条件下测试：

- 环境温度：25±2℃；
- 相对湿度：65±5%RH；
- 气压：86kPa ~ 106kPa

##### • 检查设备

外观检查：20 倍放大镜；

压敏电压测试：压敏电阻测试仪

#### 4 Test and Measurement Procedures

##### • Test Conditions

Unless otherwise specified, the standard atmospheric conditions for measurement/test as:

- Ambient Temperature: 20±15℃
- Relative Humidity: 65±20%
- Air Pressure: 86kPa to 106kPa

If any doubt on the results, measurements/tests should be made within the following limits:

- Ambient Temperature: 25±2℃
- Relative Humidity: 65±5%
- Air Pressure: 86kPa to 106kPa

##### • Inspection Equipment

Visual Examination: 20× magnifier

Varistor Voltage test: Varistor teste

#### 5 可靠性试验 Reliability Test

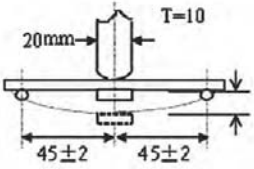
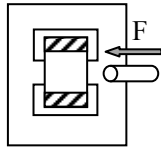
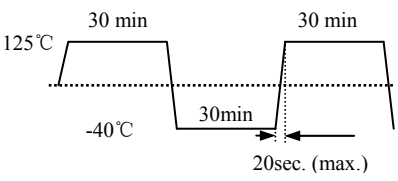
序号 No	项目 Items	测试条件/方法 Test conditions / Methods	要求 Requirements
1	抗弯强度 Bending Resistance	弯曲度 Warp: 2mm 速度 Speed<0.5mm/s 保持时间 Duration: 10s 	① 无可见机械损伤; No visible mechanical damage. ② 试验前后压敏电压变化率 ≤ 5%。 $ \Delta V_{1mA} / V_{1mA}  \leq 5\%$
2	端电极强度 Terminal Strength	速度 Speed<0.5mm/s 作用力 Apply force: 5N (0402/0603) /10N (0805~2220) 保持时间 Duration: 10±1s 	端电极无脱落。 No removal or split of the termination
3	可焊性 Solderability	焊接温度 Solder temperature: 240±5℃; 浸渍时间 Dipping Duration: 3±0.3s;	① 无可见机械损伤; No visible mechanical damage. ② 元件端电极的焊锡覆盖率达 90%。 Wetting shall exceed 90% coverage.
4	耐焊性 Resistance to Soldering Heat	焊接温度 Solder temperature: 260±5℃; 浸渍时间 Dipping Duration: 5±1s;	① 无可见机械损伤; No visible mechanical damage. ② 试验前后压敏电压变化率 ≤ 10%。 $ \Delta V_{1mA} / V_{1mA}  \leq 10\%$
5	热冲击 Thermal Shock	高低温交替冲击 100 次。 High and low temperatures Transform for 100 Cycles. 	① 无可见机械损伤; No visible mechanical damage. ② 试验前后压敏电压变化率 ≤ 10%。 $ \Delta V_{1mA} / V_{1mA}  \leq 10\%$

6	高温存放 High Temp. Storage	温度 Temperature: 125±2℃ 保持时间 Duration: 1000±24 h.	① 无可见机械损伤; No visible mechanical damage. ② 试验前后压敏电压变化率 ≤ 10%。 $ \Delta V_{1mA}/V_{1mA}  \leq 10\%$ .
7	低温存放 Low Temp. Storage	温度 Temperature: -40±2℃ 保持时间 Duration: 1000±24 h.	① 无可见机械损伤; No visible mechanical damage. ② 试验前后压敏电压变化率 ≤ 10%。 $ \Delta V_{1mA}/V_{1mA}  \leq 10\%$ .
8	高温负载 High Temp. Load	温度 Temperature: 85±2℃ 加载电压 Loading Voltage: $V_{DC}$ . 保持时间 Duration: 1000±24 h.	① 无可见机械损伤; No visible mechanical damage. ② 试验前后压敏电压变化率 ≤ 10%。 $ \Delta V_{1mA}/V_{1mA}  \leq 10\%$ .
9	湿热负载 Damp Heat Load	温度 Temperature: 40±2℃ 湿度 Humidity: 90% ~ 95% RH. 加载电压 Loading Voltage: $V_{DC}$ . 保持时间 Duration: 500±12 h.	① 无可见机械损伤; No visible mechanical damage. ② 试验前后压敏电压变化率 ≤ 10%。 $ \Delta V_{1mA}/V_{1mA}  \leq 10\%$ .
10	最大浪涌电流 Maximum Surge Current	脉冲波形 Pulse waveform: 8/20 us 冲击次数: 正反各 1 次 Number of hit: each 1 time of +/- polarity 冲击电流: 最大浪涌电流 Applied current: maximum surge current ( $I_p$ )	① 无可见机械损伤; No visible mechanical damage. ② 试验前后压敏电压变化率 ≤ 10%。 $ \Delta V_{1mA}/V_{1mA}  \leq 10\%$ .
11	最大浪涌能量 Maximum Surge Energy	脉冲波形 Pulse waveform: 10/1000 us 冲击次数: 正反各 1 次 Number of hit: each 1 time of +/- polarity 冲击电流: 最大浪涌能量( $W_{max}$ ) Applied current: maximum surge energy( $W_{max}$ )	① 无可见机械损伤; No visible mechanical damage. ② 试验前后压敏电压变化率 ≤ 10%。 $ \Delta V_{1mA}/V_{1mA}  \leq 10\%$ .

## 6 编带 Taping

(1) 载带尺寸 (单位: mm)

Carrier tape dimensions. (Unit: mm)

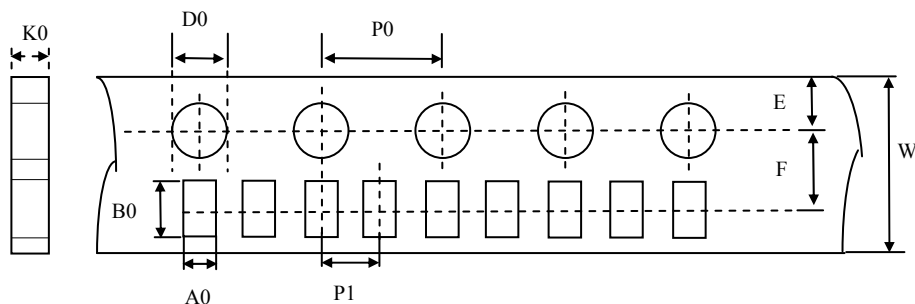

类型 Type	A0	B0	W	E	F	P1	P0	D0	K0
0402	0.65±0.2	1.15±0.2	8.0±0.3	1.75±0.1	3.5±0.1	2.0±0.1	4.0±0.1	1.55±0.1	0.8 Max.
0603	1.05±0.2	1.85±0.2	8.0±0.3	1.75±0.1	3.5±0.1	4.0±0.1	4.0±0.1	1.55±0.1	1.1 Max.
0805	1.5±0.2	2.3±0.2	8.0±0.3	1.75±0.1	3.5±0.1	4.0±0.1	4.0±0.1	1.55±0.1	1.1 Max.

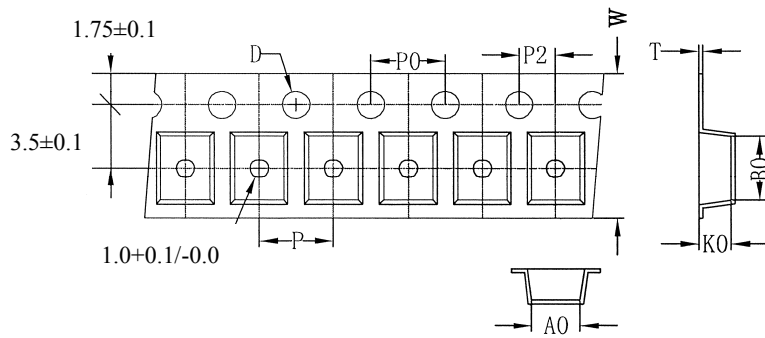

类型 Type	A0 (±0.2)	B0 (±0.2)	K0 (±0.2)	T (±0.05)	W (±0.2)	P0 (±0.2)	P (±0.2)	P2 (±0.2)
1206	1.9	3.5	1.27	0.22	8.0	4.0	4.0	2.0
1210	2.8	3.5	1.5	0.22	8.0	4.0	4.0	2.0
1812	3.5	4.8	1.8	0.25	12.0	4.0	8.0	2.0
2220	5.1	6.0	2.2	0.25	12.0	4.0	8.0	2.0

(2) 卷盘尺寸 Taping reel dimensions

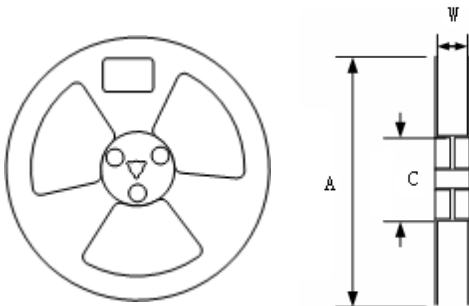

类型 Type	规格 Spec.	尺寸 Dimensions(mm)		
		A	W	C
0402	7"	178±2	8.4+2.0/-0.0	58±2
0603	7"	178±2	8.4+2.0/-0.0	58±2
0805	7"	178±2	8.4+2.0/-0.0	58±2
1206	7"	178±2	8.4+2.0/-0.0	58±2
1210	7"	178±2	8.4+2.0/-0.0	58±2
1812	7"	178±2	12.4+2.0/-0.0	58±2
2220	7"	178±2	12.4+2.0/-0.0	58±2

(3) 包装数量 Packaging quantity

类型 Type	载带 Tape	每盘数量 (片) Quantity(pcs/reel)
0402	纸带 Paper Tape	10K
0603		4K
0805		4K
1206	塑载带 Embossed Tape	3K
1210		3K
1812		1K
2220		1K

## 7 焊接建议 Soldering Recommendation

### (1) 建议基板 Recommended Land pattern

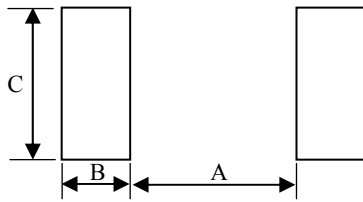

类型 Type	A (mm)	B (mm)	C (mm)
0402	0.45~0.55	0.4~0.5	0.45~0.55
0603	0.6~0.8	0.6~0.8	0.6~0.8
0805	0.8~1.2	0.8~1.2	0.9~1.6
1206	1.8~2.5	1.2~1.8	1.2~2.0
1210	1.8~2.5	1.3~2.0	2.2~3.0
1812	2.5~3.3	1.5~2.2	2.8~3.6
2220	3.8~4.6	1.5~2.2	4.8~5.5

### (2) 建议焊接曲线 Recommended Soldering Profile

- 无铅锡膏: Sn/Ag/Cu (96.5/3.0/0.5)
- 最高温度时最长焊接时间: 10s
- 允许回流焊次数: 最多 2 次
- Pb Free Solder Paste: Sn/Ag/Cu (96.5/3.0/0.5).
- Max time at max temp: 10sec.
- Allowed Reflow time: 2x Max

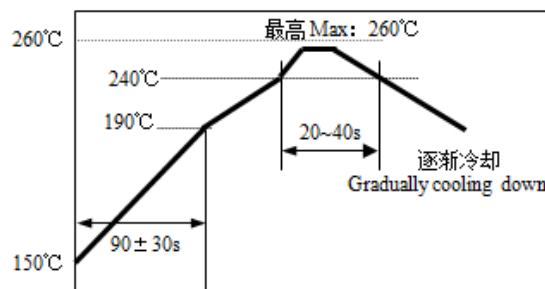

## 8 注意事项 Notes & Warnings

- 储存
  1. 初始包装贮存温度: -10°C ~ +40°C。
  2. 相对湿度: ≤70%RH。
  3. 远离腐蚀性气体和阳光。
  4. 储存期: 12 个月。
- Storage
  1. Storage temperature in original packaging: -10~+40°C.
  2. Relative Humidity: ≤70%RH.
  3. Keep away from corrosive atmosphere and sunlight.
  4. Period of Storage: 12 Months.