

Power Choke Coil for Automotive application

Series: **PCC-M0530M (MC) PCC-M0540M (MC)**
PCC-M0630M (MC) PCC-M0645M (MC)
PCC-M0754M (MC) PCC-M0750M (MC)
PCC-M0854M (MC) PCC-M0850M (MC)
PCC-M1054M (MC) PCC-M1050M (MC)
PCC-M1050ML (MC) PCC-M1060ML (MC)

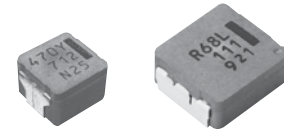

High heat resistance and high reliability
 Using metal composite core (MC)

Industrial Property : patents 21 (Registered 2/Pending 19)

Features

- High heat resistance : Operation up to 150 °C including self-heating
- High-reliability : High vibration resistance as result of newly developed integral construction; under severe reliability conditions of automotive and other strenuous applications
- High bias current : Excellent inductance stability using ferrous alloy magnetic material (Fig.1)
- Temp. stability : Excellent inductance stability over broad temp. range (Fig.1)
- Low audible (buzz) noise : New metal composite core technology
- High efficiency : Low R_{DC} of winding and low eddy-current loss of the core
- AEC-Q200 Automotive qualified
- RoHS compliant
- Shielded construction

● Fig.1 Inductance v.s. DC current, Temp.

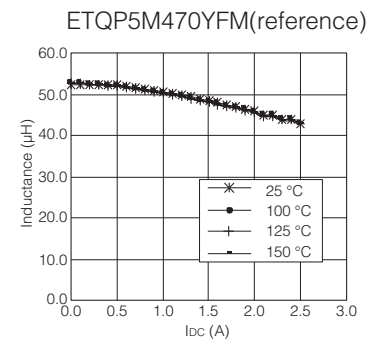

Recommended Applications

- Noise filter for various drive circuitry requiring high temp. operation and peak current handling capability
- Boost-Converter, Buck-Converter DC/DC

Standard Packing Quantity (Minimum Quantity/Packing Unit)

- 1,000 pcs./box (2 reel) : PCC-M0645M, M0754M, M0750M, M0854M, M0850M, M1054M, M1050M, M1050ML, M1060ML
- 2,000 pcs./box (2 reel) : PCC-M0530M, M0540M, M0630M

Explanation of Part Numbers

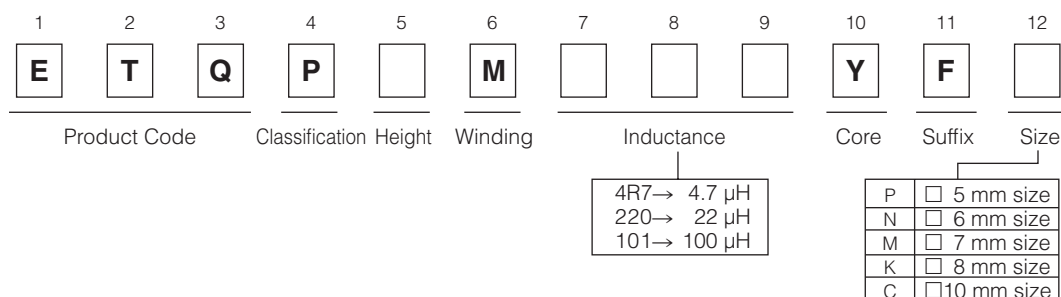

Temperature rating

| | | |
|-----------------------------|---------------------|--|
| Operating temperature range | | Tc : -40 °C to +150 °C (Including self-temperature rise) |
| Storage condition | After PWB mounting | |
| | Before PWB mounting | Ta : -5 °C to +35 °C 85%RH max. |

1. Series PCC-M0530M/PCC-M0540M (ETQP3M□□□YFP/ETQP4M□□□YFP)

Standard Parts

| Series | Part No. | Inductance *1 | | DCR (at 20 °C) (mΩ) | | Rated Current (Typ. : A) | | |
|---------------------------------|--------------|---------------|---------------|---------------------|---------------|--------------------------|------|---------|
| | | L0 (μH) | Tolerance (%) | Typ. (max.) | Tolerance (%) | ΔT=40K | | ΔL=-30% |
| | | | | | | (*2) | (*3) | (*4) |
| PCC-M0530M [5.5×5.0×3.0(mm)] | ETQP3M2R2YFP | 2.2 | ±20 | 22.6 (24.8) | ±10 | 4.8 | 5.8 | 10.9 |
| | ETQP3M3R3YFP | 3.3 | | 31.3 (34.4) | | 4.1 | 5.0 | 8.6 |
| PCC-M0540M [5.5×5.0×4.0(mm)] | ETQP4M4R7YFP | 4.7 | | 36.0 (39.6) | | 4.0 | 4.8 | 7.7 |
| | ETQP4M220YFP | 22 | 163 (179) | 1.9 | 2.3 | 3.1 | | |

(*1) Measured at 100 kHz.

(*2) DC current which causes temperature rise of 40 K. Parts are soldered by reflow on four-layer PWB (1.6 mm FR4) and measured at room temperature. See also (*5)

(*3) DC current which causes temperature rise of 40 K. Parts are soldered by reflow on multilayer PWB with high heat dissipation performance. Note: Heat radiation constant are approx. 52 K/W measured on 5.5×5.0×3.0 mm case size and approx. 48 K/W measured on 5.5×5.0×4.0 mm case size. See also (*5)

(*4) Saturation rated current : DC current which causes L(0) drop -30 %.

(*5) Within a suitable application, the part's temperature depends on circuit design and certain heat dissipation conditions. This should be double checked in a worst case operation mode.

In normal case, the max.standard operating temperature of +150 °C should not be exceeded.

For higher operating temperature conditions, please contact Panasonic representative in your area.

Performance Characteristics (Reference)

● Inductance vs DC Current

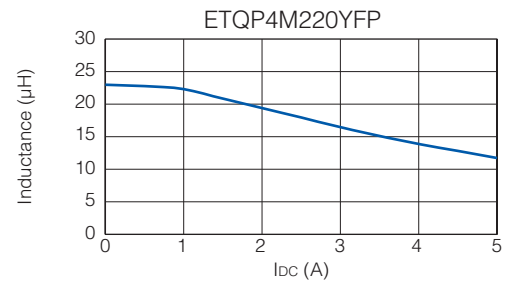
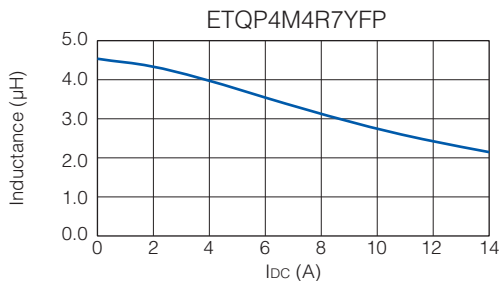
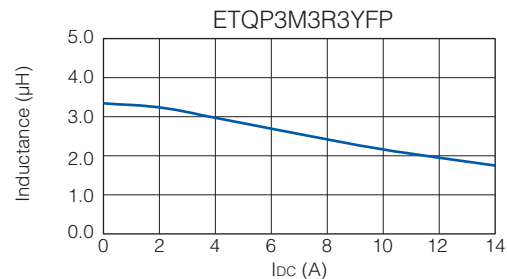
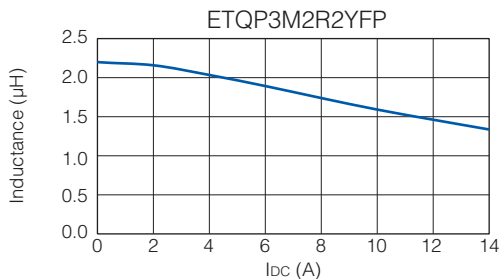

● Case Temperature vs DC Current

PWB condition A : Four-layer PWB (1.6 mm FR4), See also (*2)

PWB condition B : Multilayer PWB with high heat dissipation performance. See also (*3)

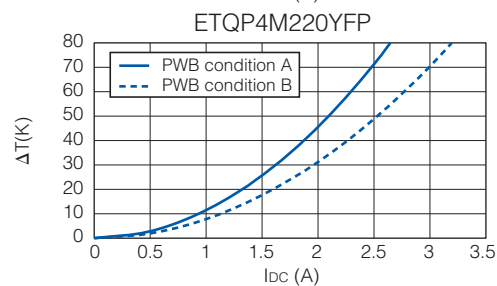
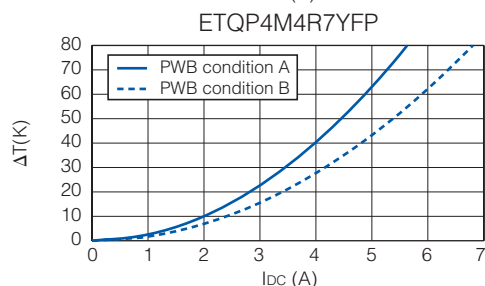
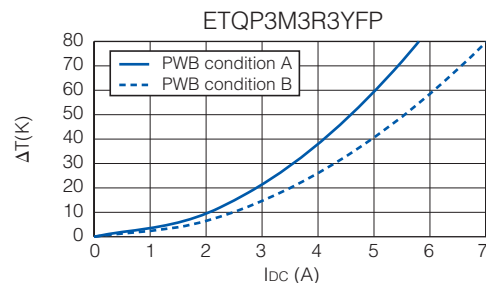
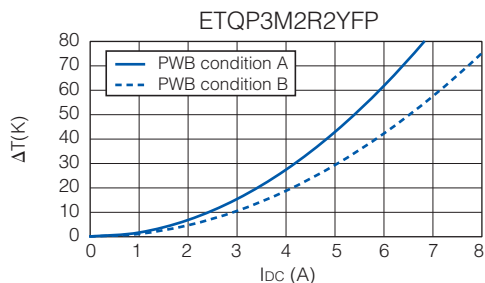

2. Series PCC-M0630M/PCC-M0645M (ETQP3M□□□YFN/ETQP4M□□□YFN)

Standard Parts

| Series | Part No. | Inductance *1 | | DCR (at 20 °C) (mΩ) | | Rated Current (Typ. : A) | | |
|---------------------------------|--------------|---------------|---------------|---------------------|---------------|--------------------------|------|---------|
| | | L0 (μH) | Tolerance (%) | Typ. (max.) | Tolerance (%) | ΔT=40K | | ΔL=-30% |
| | | | | | | (*2) | (*3) | (*4) |
| PCC-M0630M [6.5×6.0×3.0(mm)] | ETQP3MR68YFN | 0.68 | ±20 | 6.3 (6.9) | ±10 | 9.8 | 12.0 | 24.0 |
| | ETQP3M1R0YFN | 1.0 | | 7.9 (8.7) | | 8.8 | 10.7 | 20.0 |
| PCC-M0645M [6.5×6.0×4.5(mm)] | ETQP4M6R8YFN | 6.8 | ±20 | 39.3 (43.2) | ±10 | 4.1 | 5.2 | 10.0 |
| | ETQP4M100YFN | 10 | | 54.2 (59.6) | | 3.3 | 4.5 | 8.3 |
| | ETQP4M470YFN | 47 | | 210 (231) | | 1.8 | 2.2 | 3.8 |

(*1) Measured at 100 kHz.

(*2) DC current which causes temperature rise of 40 K. Parts are soldered by reflow on four-layer PWB (1.6 mm FR4) and measured at room temperature. See also (*5)

(*3) DC current which causes temperature rise of 40 K. Parts are soldered by reflow on multilayer PWB with high heat dissipation performance. Note: Heat radiation constant are approx. 44 K/W measured on 6.5×6.0×3.0 mm case size and approx. 37 K/W measured on 6.5×6.0×4.5 mm case size. See also (*5)

(*4) Saturation rated current : DC current which causes L(0) drop -30 %.

(*5) Within a suitable application, the part's temperature depends on circuit design and certain heat dissipation conditions. This should be double checked in a worst case operation mode.

In normal case, the max. standard operating temperature of +150 °C should not be exceeded.

For higher operating temperature conditions, please contact Panasonic representative in your area.

Performance Characteristics (Reference)

● Inductance vs DC Current

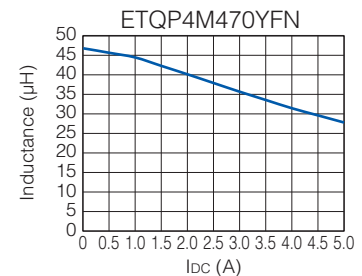
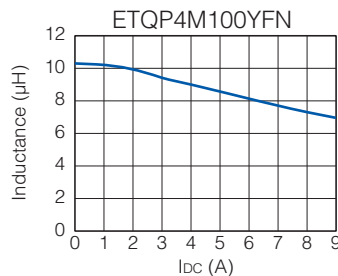
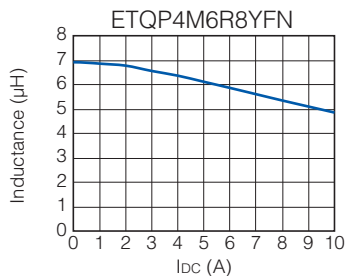
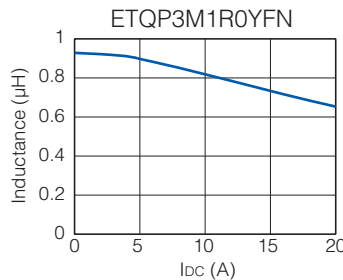
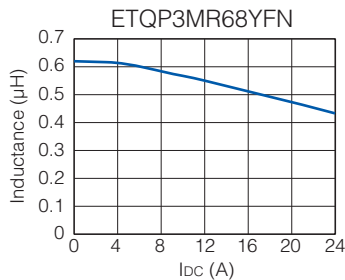

● Case Temperature vs DC Current

PWB condition A : Four-layer PWB (1.6 mm FR4), See also (*2)

PWB condition B : Multilayer PWB with high heat dissipation performance. See also (*3)

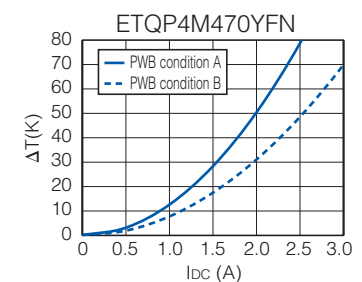
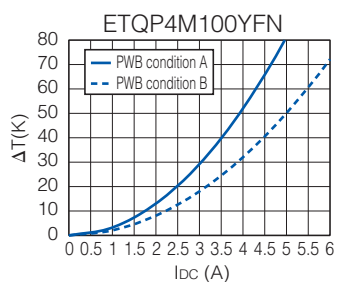
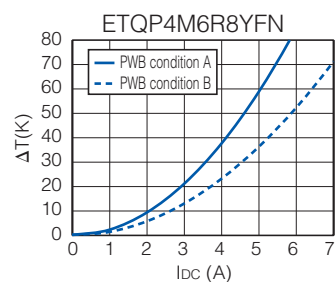
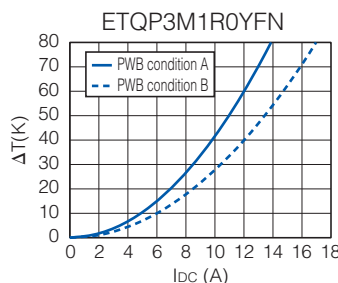
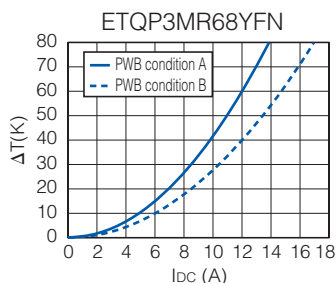

3. Series PCC-M0754M/PCC-M0750M (ETQP5M□□□YFM/ETQP5M□□□YGM)

Standard Parts

| Series | Part No. | Inductance *1 | | DCR (at 20 °C) (mΩ) | | Rated Current (Typ. : A) | | |
|---------------------------------|--------------|---------------|---------------|---------------------|---------------|--------------------------|------|---------|
| | | L0 (μH) | Tolerance (%) | Typ. (max.) | Tolerance (%) | ΔT=40K | | ΔL=-30% |
| | | | | | | (*2) | (*3) | (*4) |
| PCC-M0754M [7.5×7.0×5.4(mm)] | ETQP5M4R7YFM | 4.7 | ±20 | 20(23) | ±10 | 6.3 | 8.0 | 13.1 |
| | ETQP5M6R8YFM | 6.8 | | 26.7(29.4) | | 5.5 | 6.9 | 12.1 |
| | ETQP5M100YFM | 10 | | 37.6(41.3) | | 4.7 | 5.7 | 10.6 |
| | ETQP5M220YFM | 22 | | 92(102) | | 3.0 | 3.7 | 5.8 |
| | ETQP5M330YFM | 33 | | 120(132) | | 2.6 | 3.3 | 4.8 |
| | ETQP5M470YFM | 48 | | 156(172) | | 2.3 | 2.9 | 4.1 |
| PCC-M0750M [7.5×7.0×5.0(mm)] | ETQP5M101YGM | 95 | | 348(382.8) | | 1.4 | 1.9 | 3.1 |

(*1) Measured at 100 kHz.

(*2) DC current which causes temperature rise of 40 K. Parts are soldered by reflow on four-layer PWB (1.6 mm FR4) and measured at room temperature. See also (*5)

(*3) DC current which causes temperature rise of 40 K. Parts are soldered by reflow on multilayer PWB with high heat dissipation performance. Note: Heat radiation constant is approx. 31 K/W measured on 7.5×7.0×5.4 mm case size and approx. 29 K/W measured on 7.5×7.0×5.0 mm case size. See also (*5)

(*4) Saturation rated current : DC current which causes L(0) drop -30 %.

(*5) Within a suitable application, the part's temperature depends on circuit design and certain heat dissipation conditions. This should be double checked in a worst case operation mode.

In normal case, the max.standard operating temperature of +150 °C should not be exceeded.

For higher operating temperature conditions, please contact Panasonic representative in your area.

Performance Characteristics (Reference)

● Inductance vs DC Current

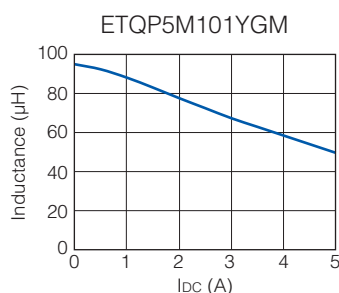
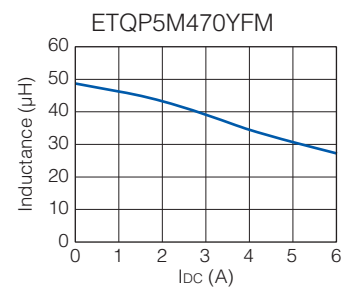
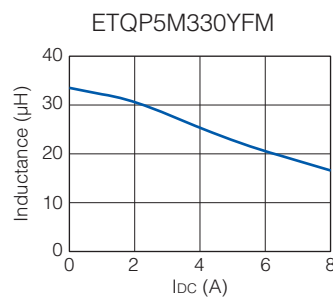
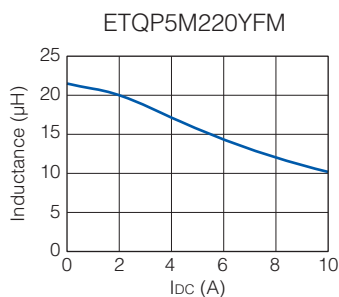
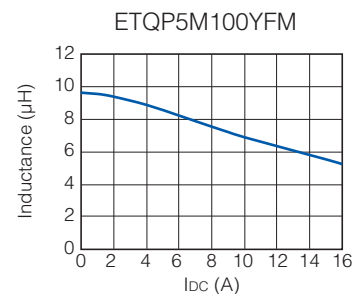
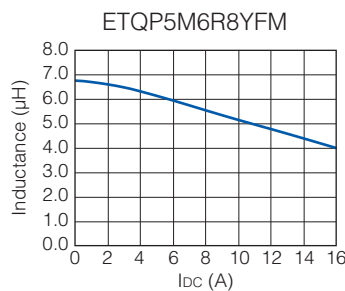
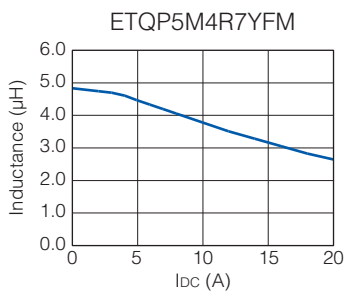

● Case Temperature vs DC Current

PWB condition A : Four-layer PWB (1.6 mm FR4), See also (*2)

PWB condition B : Multilayer PWB with high heat dissipation performance. See also (*3)

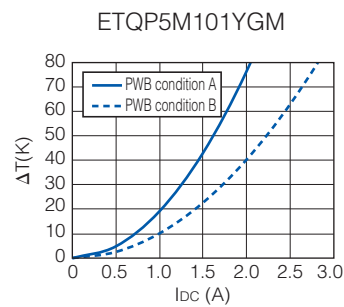
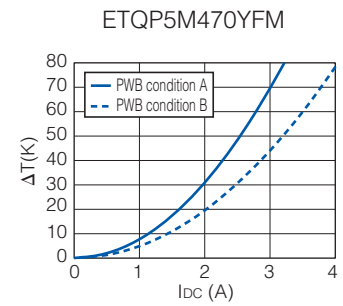
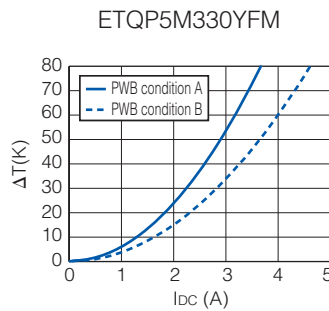
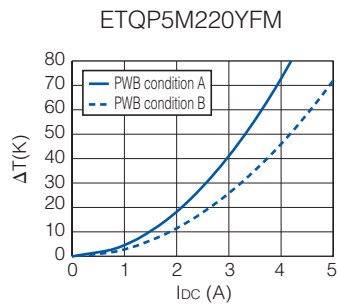
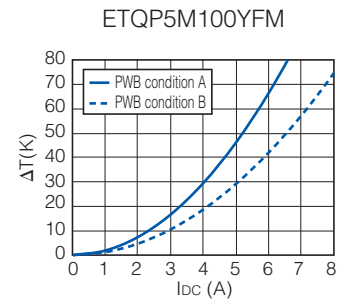
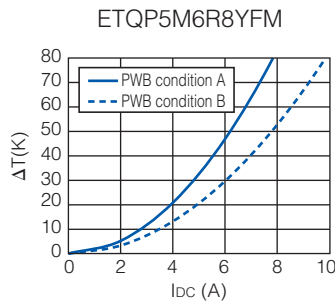
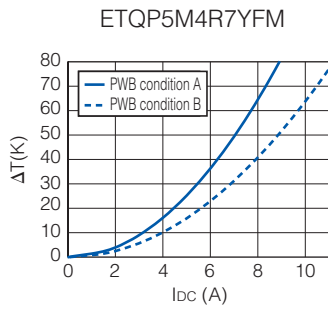

4. Series PCC-M0854M/PCC-M0850M (ETQP5M□□□YFK/ETQP5M□□□YGK)

Standard Parts

| Series | Part No. | Inductance *1 | | DCR (at 20 °C) (mΩ) | | Rated Current (Typ. : A) | | |
|---------------------------------|--------------|---------------|---------------|---------------------|---------------|--------------------------|------|--------------|
| | | L0 (μH) | Tolerance (%) | Typ. (max.) | Tolerance (%) | ΔT=40K | | ΔL=-30% (*4) |
| | | | | | | (*2) | (*3) | |
| PCC-M0854M [8.5×8.0×5.4(mm)] | ETQP5M2R5YFK | 2.5 | ±20 | 7.6(8.4) | ±10 | 11.9 | 14.0 | 20.1 |
| | ETQP5M100YFK | 10 | | 33(37) | | 5.7 | 6.7 | 13.0 |
| | ETQP5M150YFK | 15 | | 48.2(53.1) | | 4.7 | 5.5 | 7.2 |
| | ETQP5M220YFK | 22 | | 63(70) | | 4.1 | 4.8 | 6.9 |
| | ETQP5M470YFK | 48 | | 125(138) | | 2.9 | 3.4 | 5.4 |
| PCC-M0850M [8.5×8.0×5.0(mm)] | ETQP5M101YGK | 100 | | 302(333) | | 1.7 | 2.1 | 3.0 |

(*1) Measured at 100 kHz.

(*2) DC current which causes temperature rise of 40 K. Parts are soldered by reflow on four-layer PWB (1.6 mm FR4) and measured at room temperature. See also (*5)

(*3) DC current which causes temperature rise of 40 K. Parts are soldered by reflow on multilayer PWB with high heat dissipation performance. Note: Heat radiation constant are approx. 27 K/W measured on 8.5×8.0×5.4 mm case size and approx. 29 K/W measured on 8.5×8.0×5.0 mm case size. See also (*5)

(*4) Saturation rated current : DC current which causes L(0) drop -30 %.

(*5) Within a suitable application, the part's temperature depends on circuit design and certain heat dissipation conditions. This should be double checked in a worst case operation mode.

In normal case, the max.standard operating temperature of + 150 °C should not be exceeded.

For higher operating temperature conditions, please contact Panasonic representative in your area.

Performance Characteristics (Reference)

● Inductance vs DC Current

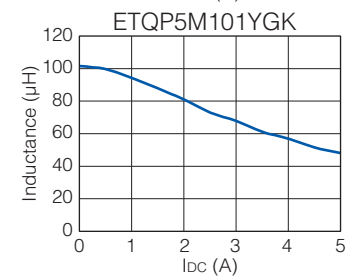
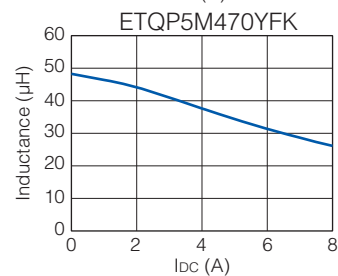
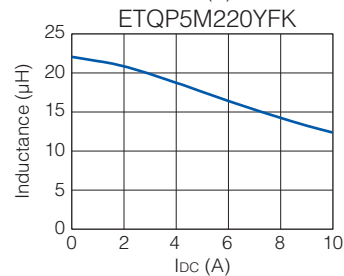
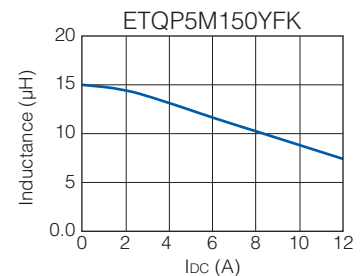
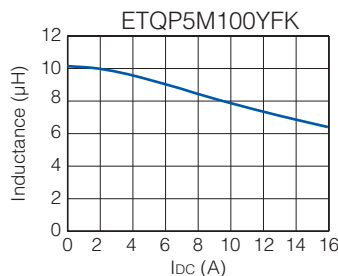
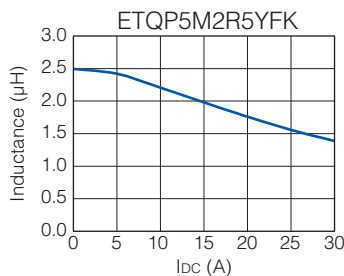

● Case Temperature vs DC Current

PWB condition A : Four-layer PWB (1.6 mm FR4), See also (*2)

PWB condition B : Multilayer PWB with high heat dissipation performance. See also (*3)

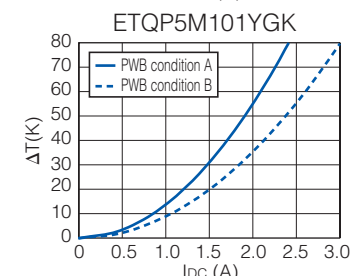
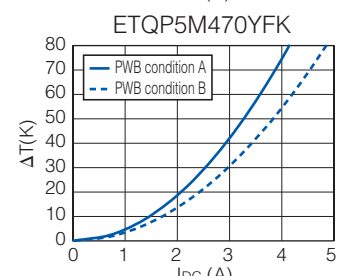
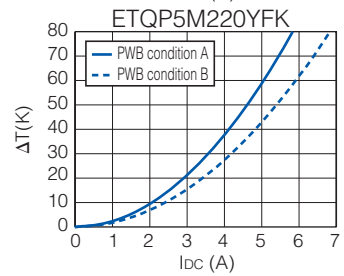
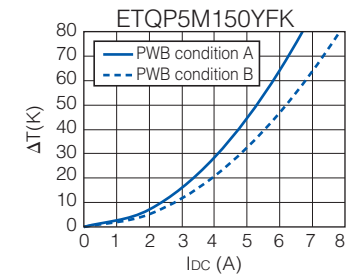
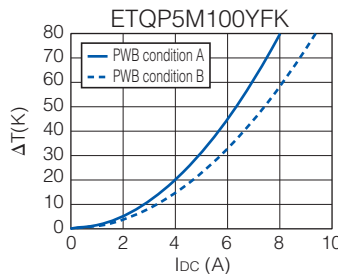
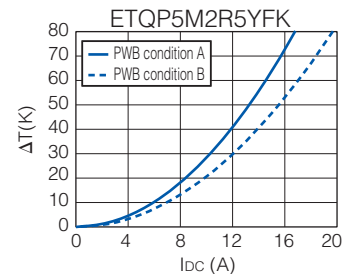

5. Series PCC-M1054M/PCC-M1050M (ETQP5M□□□YFC/ETQP5M□□□YGC)

Standard Parts

| Series | Part No. | Inductance *1 | | DCR (at 20 °C) (mΩ) | | Rated Current (Typ. : A) | | |
|-----------------------------------|--------------|---------------|---------------|---------------------|---------------|--------------------------|-------------|--------------|
| | | L0 (μH) | Tolerance (%) | Typ. (max.) | Tolerance (%) | ΔT=40K (*2) | ΔT=40K (*3) | ΔL=-30% (*4) |
| PCC-M1054M [10.7×10.0×5.4(mm)] | ETQP5M1R5YFC | 1.45 | ±20 | 3.8(4.2) | ±10 | 17.9 | 21.4 | 35.1 |
| | ETQP5M2R5YFC | 2.5 | | 5.3(5.9) | | 15.1 | 18.1 | 27.2 |
| | ETQP5M3R3YFC | 3.3 | | 7.1(7.9) | | 13.1 | 15.7 | 22.7 |
| | ETQP5M4R7YFC | 4.7 | | 10.2(11.3) | | 10.9 | 13.1 | 20.0 |
| | ETQP5M100YFC | 10 | | 23.8(26.2) | | 7.1 | 8.5 | 10.7 |
| | ETQP5M220YFC | 22 | | 45(50) | | 5.2 | 6.2 | 8.8 |
| | ETQP5M330YFC | 32.5 | | 68.5(75.4) | | 4.2 | 5.0 | 7.6 |
| | ETQP5M470YFC | 47 | | 99(108.9) | | 3.5 | 4.2 | 6.8 |
| PCC-M1050M [10.7×10.0×5.0(mm)] | ETQP5M680YFC | 66 | 136(149.6) | 3.0 | 3.6 | 4.9 | | |
| | ETQP5M101YGC | 97 | 208(229) | 2.2 | 2.7 | 3.0 | | |

(*1) Measured at 100 kHz.

(*2) DC current which causes temperature rise of 40 K. Parts are soldered by reflow on four-layer PWB (1.6 mm FR4) and measured at room temperature. See also (*5)

(*3) DC current which causes temperature rise of 40 K. Parts are soldered by reflow on multilayer PWB with high heat dissipation performance. Note: Heat radiation constant are approx. 23 K/W measured on 10.7×10.0×5.4 mm case size and approx. 26 K/W measured on 10.7×10.0×5.0 mm case size. See also (*5)

(*4) Saturation rated current : Dc current which causes L(0) drop -30 %.

(*5) Within a suitable application, the part's temperature depends on circuit design and certain heat dissipation conditions. This should be double checked in a worst case operation mode.

In normal case, the max.standard operating temperature of +150 °C should not be exceeded.

For higher operating temperature conditions, please contact Panasonic representative in your area.

Performance Characteristics (Reference)

● Inductance vs DC Current

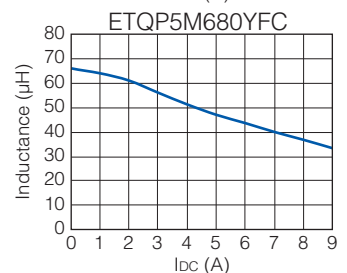
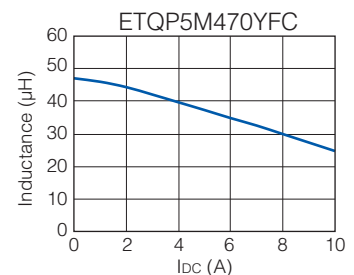
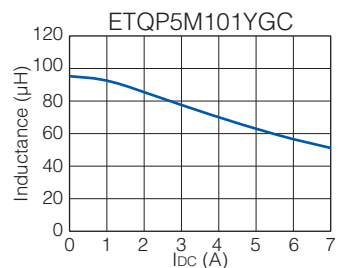
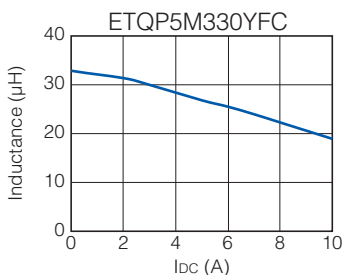
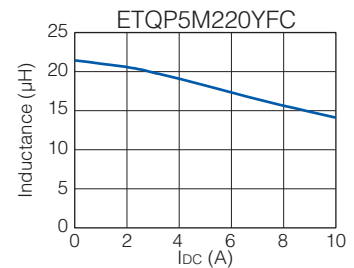
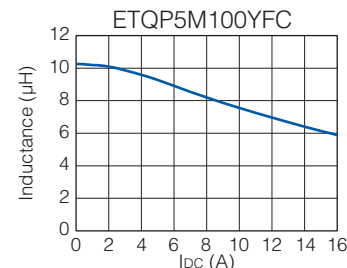
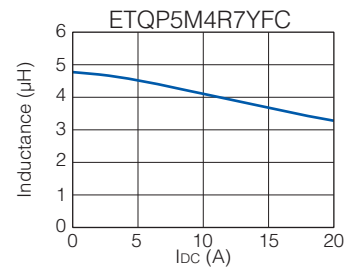
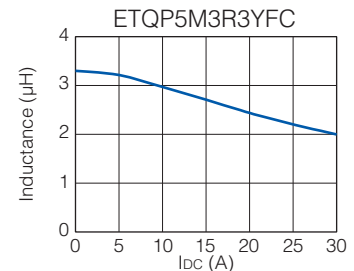
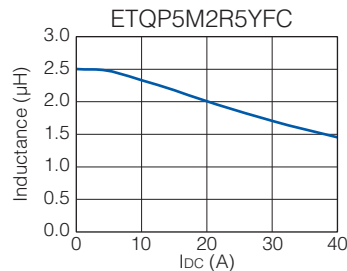
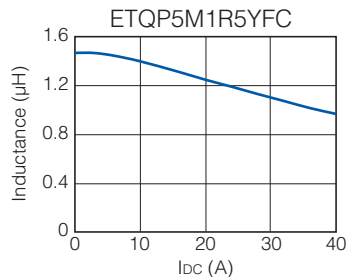

● Case Temperature vs DC Current

PWB condition A : Four-layer PWB (1.6 mm FR4), See also (*2)

PWB condition B : Multilayer PWB with high heat dissipation performance. See also (*3)

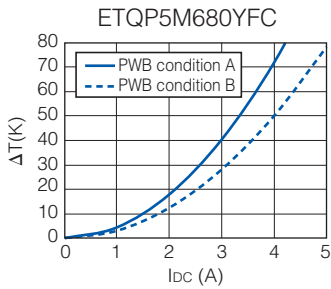
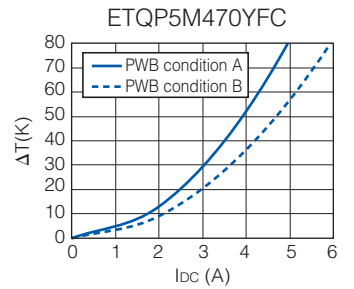
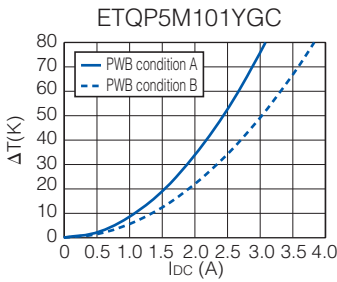
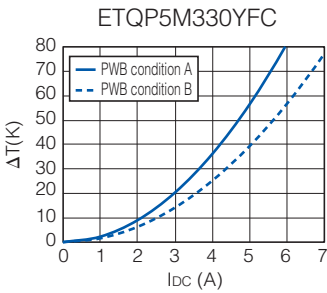
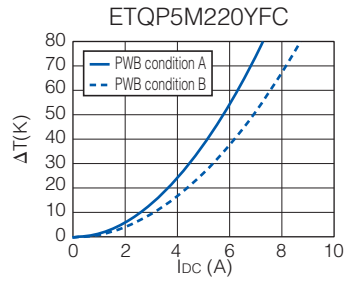
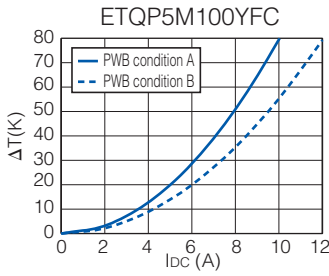
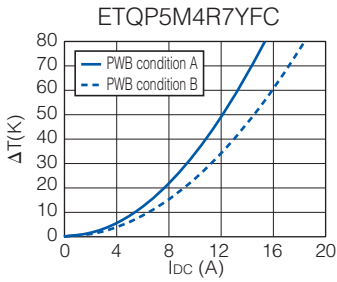
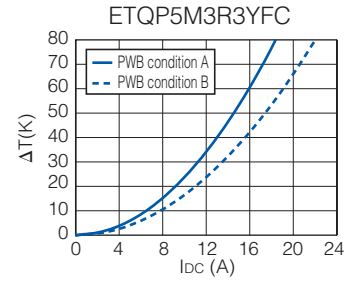
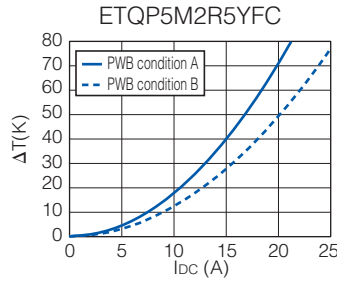
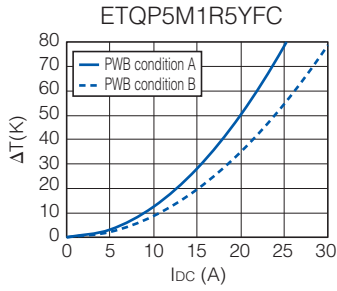

6. Series PCC-M1050ML/PCC-M1060ML (ETQP5M□□□YLC/ETQP6M□□□YLC)

Standard Parts

| Series | Part No. | Inductance *1 | | DCR (at 20 °C) (mΩ) | | Rated Current (Typ. : A) | | |
|------------------------------------|--------------|---------------|------------------|---------------------|------------------|--------------------------|------|---------|
| | | L0 (μH) | Tolerance (%) | Typ. (max.) | Tolerance (%) | ΔT=40K | | ΔL=-30% |
| | | | | | | (*2) | (*3) | (*4) |
| PCC-M1050ML [10.9×10.0×5.0(mm)] | ETQP5MR68YLC | 0.68 | ±20 | 1.75(1.93) | ±10 | 26.3 | 31.5 | 42.0 |
| | ETQP5M1R0YLC | 1.0 | | 2.3(2.53) | | 23.0 | 27.5 | 38.0 |
| | ETQP5M2R0YLC | 2.0 | | 4.6(5.06) | | 16.2 | 19.4 | 22.7 |
| PCC-M1060ML [10.9×10.0×6.0(mm)] | ETQP6M1R5YLC | 1.5 | ±20 | 3.2(3.52) | ±10 | 19.5 | 23.3 | 26.8 |
| | ETQP6M2R5YLC | 2.5 | | 4.5(5.0) | | 16.3 | 19.6 | 27.0 |
| | ETQP6M3R3YLC | 3.3 | | 6.0(6.6) | | 14.2 | 17.0 | 26.0 |
| | ETQP6M4R7YLC | 4.7 | | 8.7(9.57) | | 11.8 | 14.1 | 13.2 |

(*1) Measured at 100 kHz.

(*2) DC current which causes temperature rise of 40 K. Parts are soldered by reflow on four-layer PWB (1.6 mm FR4) and measured at room temperature. See also (*5)

(*3) DC current which causes temperature rise of 40 K. Parts are soldered by reflow on multilayer PWB with high heat dissipation performance. Note: Heat radiation constant are approx. 23 K/W measured on 10.9×10.0×5.0 mm case size and approx. 23 K/W measured on 10.9×10.0×6.0 mm case size. See also (*5)

(*4) Saturation rated current : Dc current which causes L(0) drop -30 %.

(*5) Within a suitable application, the part's temperature depends on circuit design and certain heat dissipation conditions. This should be double checked in a worst case operation mode.

In normal case, the max.standard operating temperature of +150 °C should not be exceeded.

For higher operating temperature conditions, please contact Panasonic representative in your area.

Performance Characteristics (Reference)

● Inductance vs DC Current

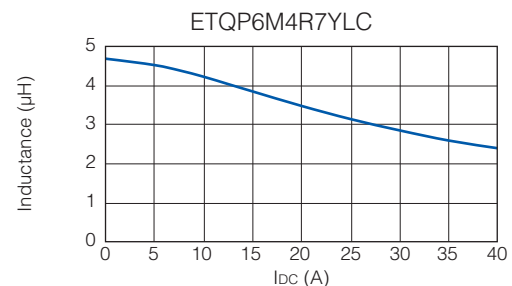
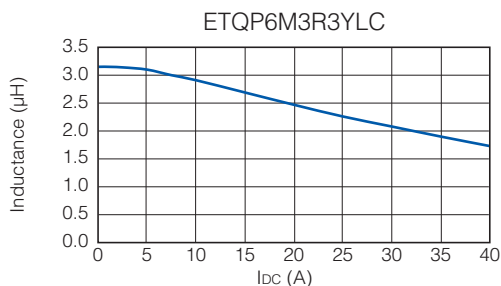
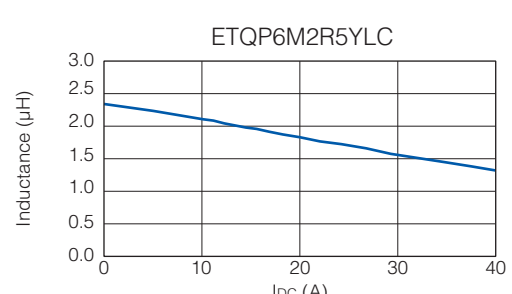
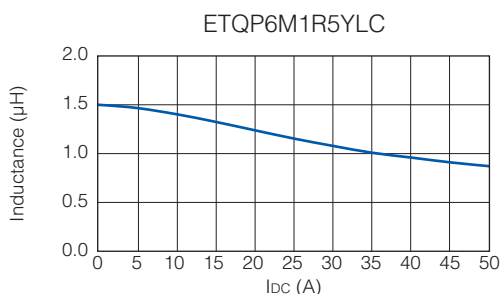
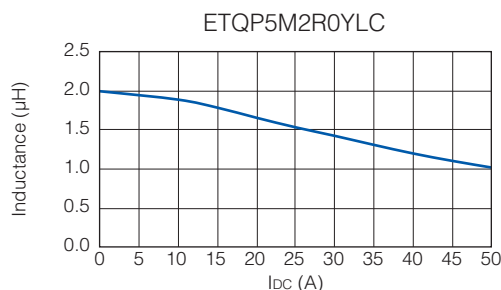
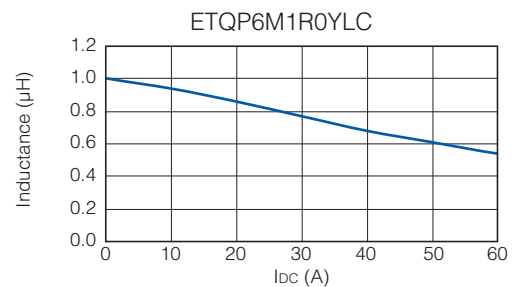
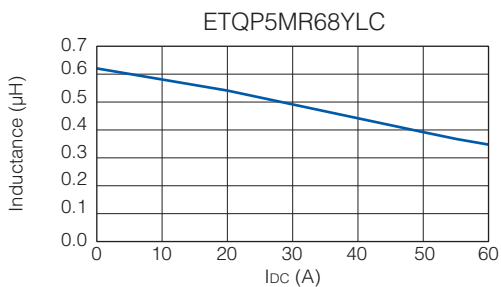

● Case Temperature vs DC Current

PWB condition A : Four-layer PWB (1.6 mm FR4), See also (*2)

PWB condition B : Multilayer PWB with high heat dissipation performance. See also (*3)

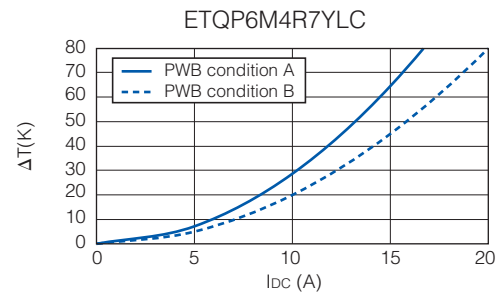
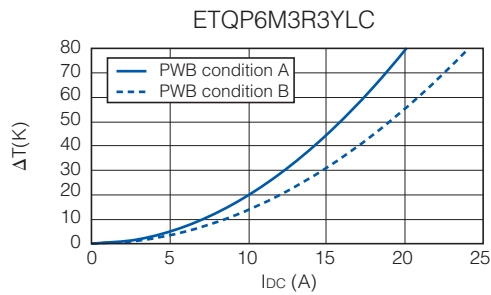
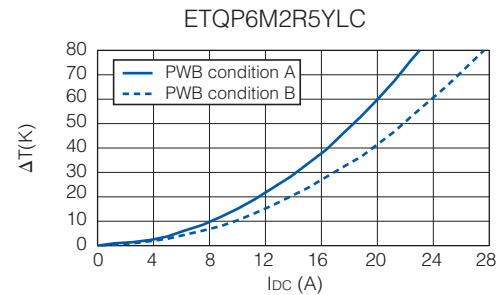
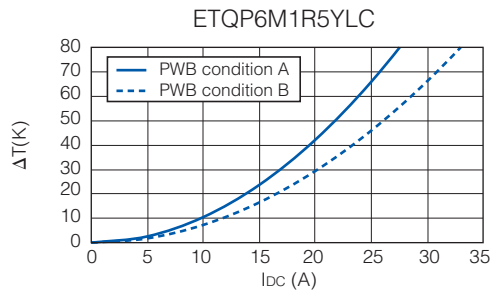
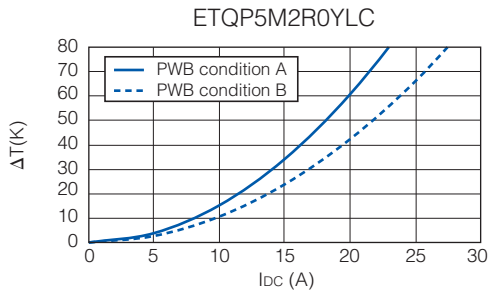
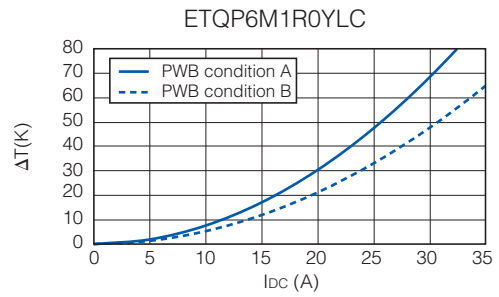
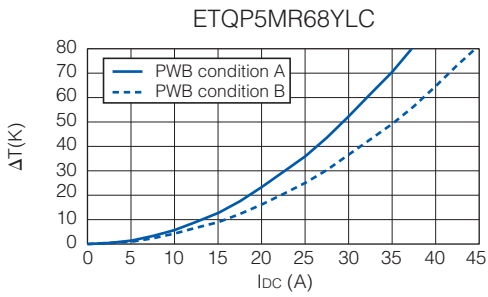

Dimensions in mm (not to scale)

Dimensional tolerance unless noted : ± 0.5

Series PCC-M0530M
Series PCC-M0540M
(ETQP3M□□□YFP/ETQP4M□□□YFP)

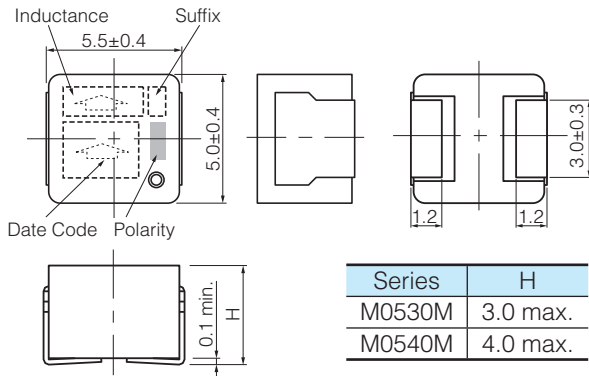

Series PCC-M0630M
Series PCC-M0645M
(ETQP3M□□□YFN/ETQP4M□□□YFN)

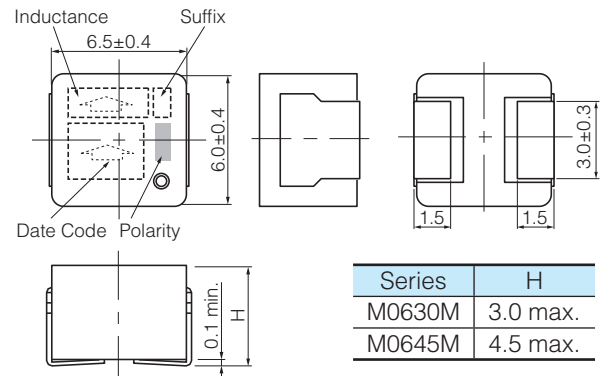

Series PCC-M0754M
Series PCC-M0750M
(ETQP5M□□□YFM/YGM)

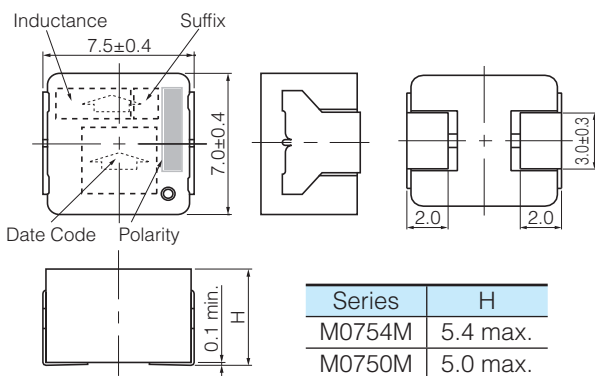

Series PCC-M0854M
Series PCC-M0850M
(ETQP5M□□□YFK/YGK)

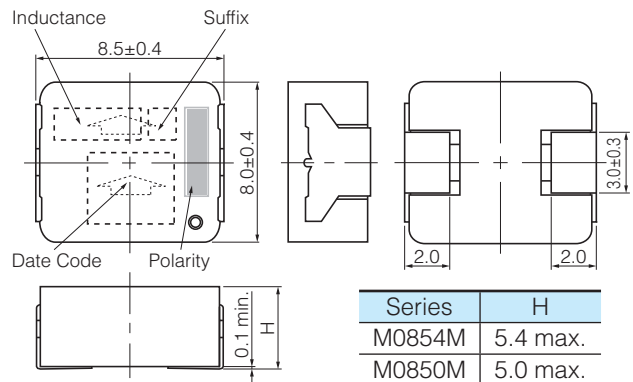

Series PCC-M1054M
Series PCC-M1050M
(ETQP5M□□□YFC/YGC)

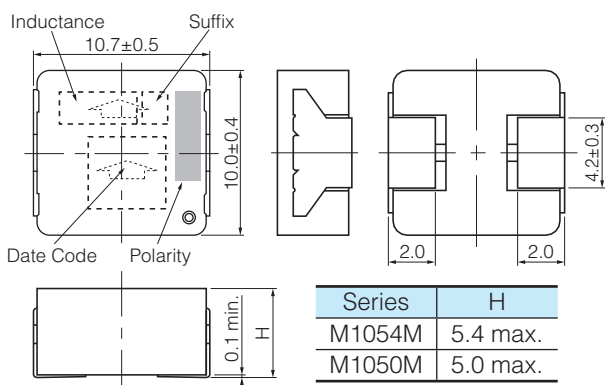

Series PCC-M1050ML
Series PCC-M1060ML
(ETQP5M□□□YLC/ETQP6M□□□YLC)

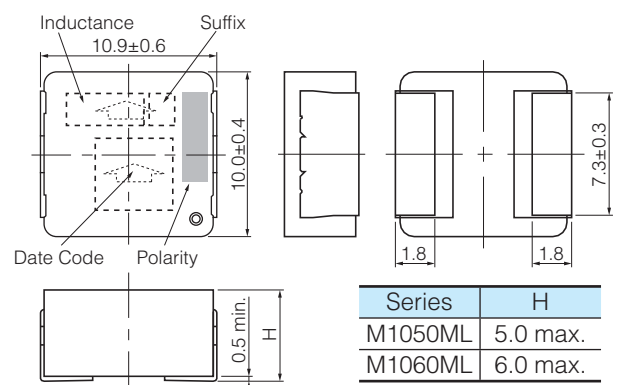

Recommended Land Pattern in mm (not to scale)

Dimensional tolerance unless noted : ± 0.5

Series PCC-M0530M
Series PCC-M0540M
(ETQP3M□□□YFP/ETQP4M□□□YFP)

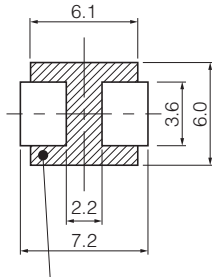

Don't wire on the pattern on shaded portion the PWB.

Series PCC-M0630M
Series PCC-M0645M
(ETQP3M□□□YFN/ETQP4M□□□YFN)

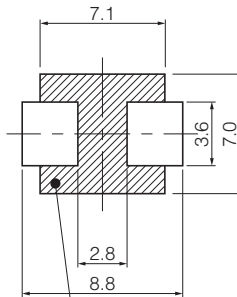

The same as the left.

Series PCC-M0754M
Series PCC-M0750M
(ETQP5M□□□YFM/YGM)

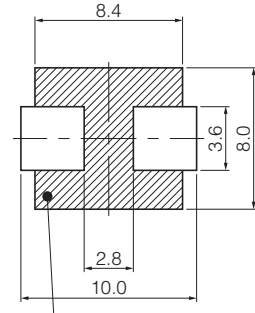

The same as the left.

Series PCC-M0854M
Series PCC-M0850M
(ETQP5M□□□YFK/YGK)

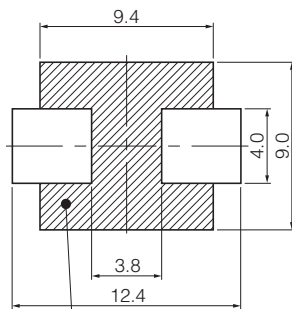

Don't wire on the pattern on shaded portion the PWB.

Series PCC-M1054M
Series PCC-M1050M
(ETQP5M□□□YFC/YGC)

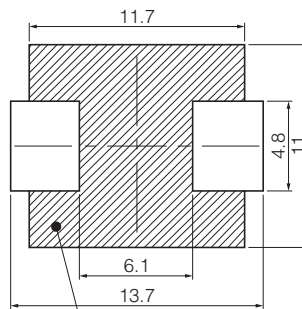

The same as the left.

Series PCC-M1050ML
Series PCC-M1060ML
(ETQP5M□□□YLC/ETQP6M□□□YLC)

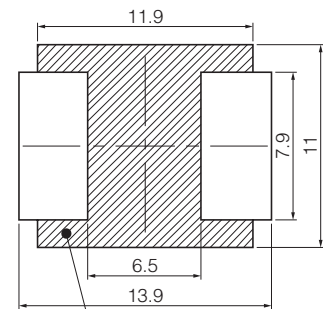

The same as the left.

■ As for Packaging Methods, Soldering Conditions and Safety Precautions (Power Choke Coils for Automotive application),

Please see Data Files