

Power Choke Coil for Automotive application

Series: **PCC-M0530M-LP(MC)**
PCC-M0630M-LP(MC)
PCC-M0840M-LP(MC)
PCC-M1040M-LP(MC)



High heat resistance and high reliability
 Using metal composite core (MC)

Industrial Property : patents 3 (Registered 2/Pending 1)

Features

- High heat resistance : Operation up to 155 °C including self-heating
- Low profile : 3 mm max. height (PCC-M0530M-LP, PCC-M0630M-LP)
4 mm max. height (PCC-M0840M-LP, PCC-M1040M-LP)
- SMD type
- High-reliability : High vibration resistance as result of newly developed integral construction; under severe reliability conditions of automotive and other strenuous applications
- High bias current : Excellent inductance stability using ferrous alloy magnetic material (Fig.1)
- Temp. stability : Excellent inductance stability over broad temp. range
- Low audible (buzz) noise : New metal composite core technology
- High efficiency : Low R_{DC} of winding and low eddy-current loss of the core
- AEC-Q200 Automotive qualified
- RoHS compliant
- Shielded construction

● Fig.1 Inductance v.s. DC current

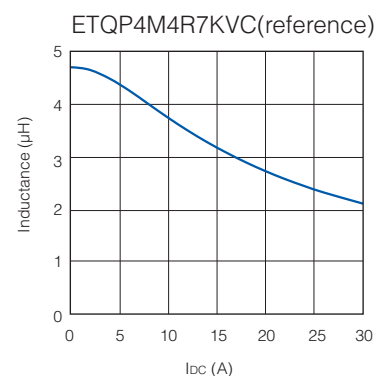

Recommended Applications

- Noise filter for various drive circuitry requiring high temp. operation and peak current handling capability
- Boost-Converter, Buck-Converter DC/DC

Standard Packing Quantity (Minimum Quantity/Packing Unit)

- 4,000 pcs./box (2 reel) : PCC-M0530M-LP, PCC-M0630M-LP
- 1,000 pcs./box (2 reel) : PCC-M0840M-LP, PCC-M1040M-LP

Explanation of Part Numbers

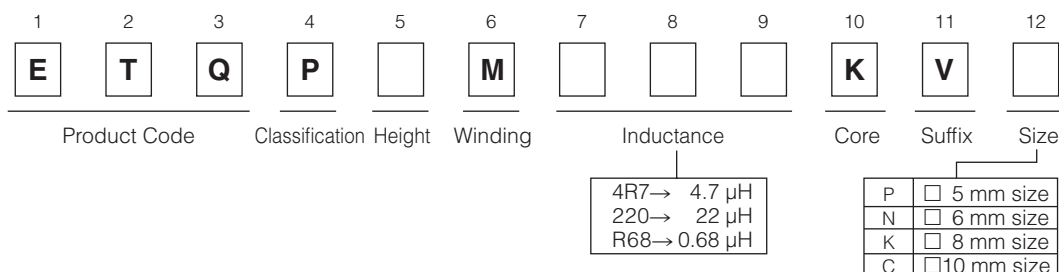

Temperature rating

Operating temperature range		Tc : -55 °C to +155 °C(Including self-temperature rise)
Storage condition	After PWB mounting	
	Before PWB mounting	Ta : -5 °C to +35 °C 85%RH max.

1. Series PCC-M0530M-LP (ETQP3M□□□KVP)

Standard Parts

Series	Part No.	Inductance *1		DCR (at 20 °C) (mΩ)		Rated Current (Typ. : A)		
		L0 (μH)	Tolerance (%)	Typ. (max.)	Tolerance (%)	ΔT=40K		ΔL=-30%
						(*2)	(*3)	(*4)
PCC-M0530M-LP [5.5×5.0×3.0(mm)]	ETQP3M100KVP	10.00	±20	96 (105.6)	±10	2.4	2.9	4.2
	▲ETQP3M6R8KVP	6.80		65.7 (72.27)		2.9	3.5	6.1
	▲ETQP3M4R7KVP	4.70		45.6 (50.16)		3.4	4.1	6.7
	▲ETQP3M3R3KVP	3.30		27.3 (30.03)		4.4	5.4	8.0
	▲ETQP3M2R2KVP	2.20		20 (22)		5.2	6.3	10.1
	▲ETQP3M1R5KVP	1.50		12 (13.2)		6.7	8.1	12.0
	ETQP3M1R0KVP	1.00		9.6 (10.56)		7.5	9.0	14.1
	▲ETQP3MR68KVP	0.68		7.6 (8.36)		8.4	10.2	15.9

(*1) Measured at 100k Hz.

(*2) DC current which causes temperature rise of 40K. Parts are soldered by reflow on four-layer PWB (1.6 mm FR4) and measured at room temperature. See also (*5)

(*3) DC current which causes temperature rise of 40K. Parts are soldered by reflow on multilayer PWB with high heat dissipation performance. Note: Heat radiation constant are approx. 51 K/W measured on 5.5×5.0×3.0 mm case size. See also (*5)

(*4) Saturation rated current : DC current which causes L(0) drop -30 %.

(*5) Within a suitable application, the part's temperature depends on circuit design and certain heat dissipation conditions. This should be double checked in a worst case operation mode.

In normal case, the max.standard operating temperature of +155 °C should not be exceeded.

For higher operating temperature conditions, please contact Panasonic representative in your area.

▲ Under development (Start of mass production : the 1st half of 2017) Please contact us for customized part no.

Performance Characteristics (Reference)

● Inductance vs DC Current

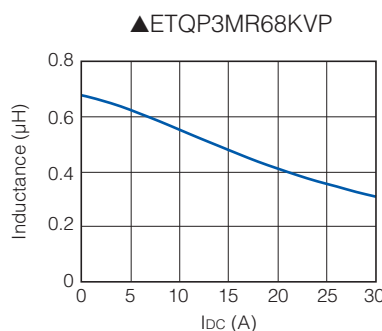
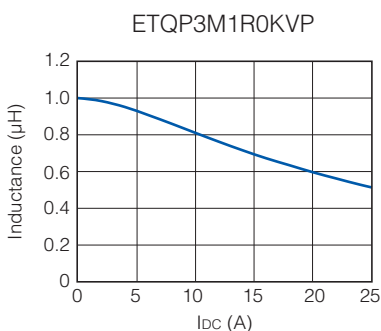
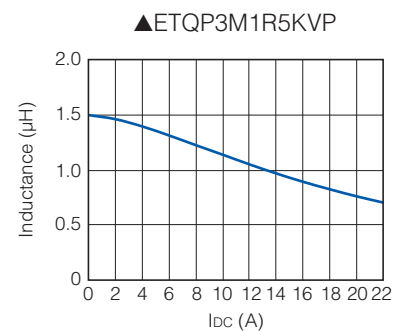
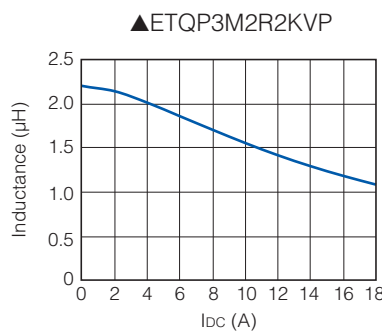
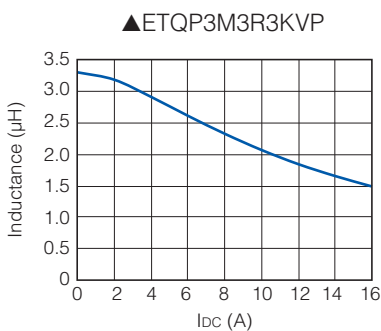
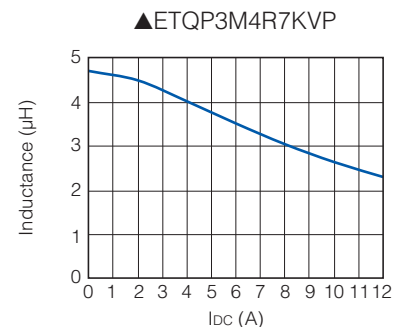
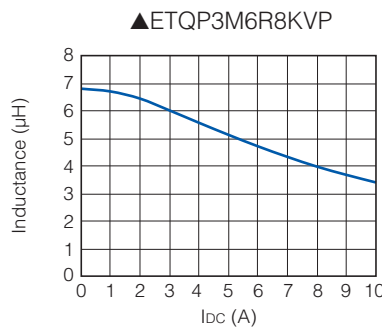
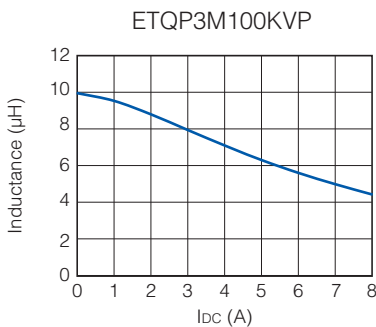

▲ Under development

Performance Characteristics (Reference)

● Case Temperature vs DC Current

PWB condition A : Four-layer PWB (1.6 mm FR4), See also (*2)

PWB condition B : Multilayer PWB with high heat dissipation performance. See also (*3)

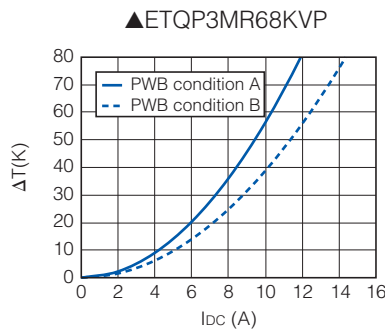
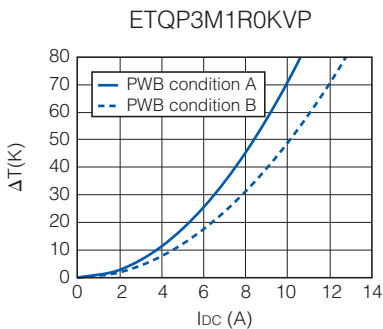
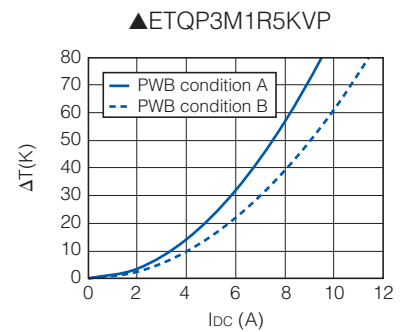
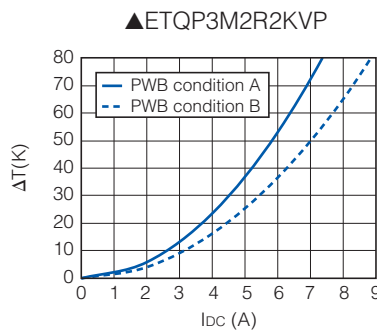
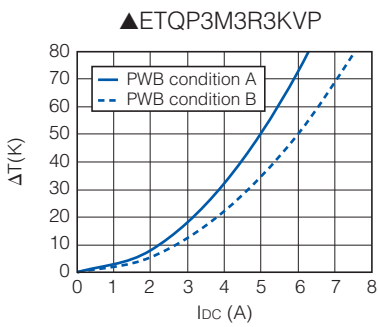
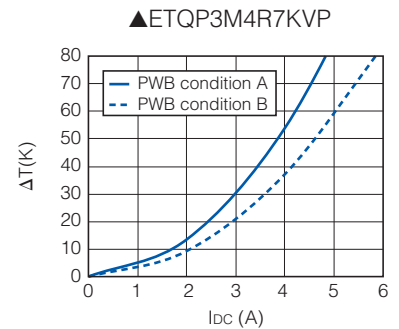
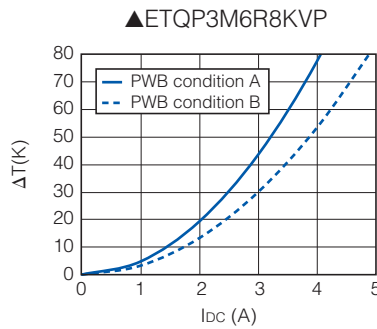
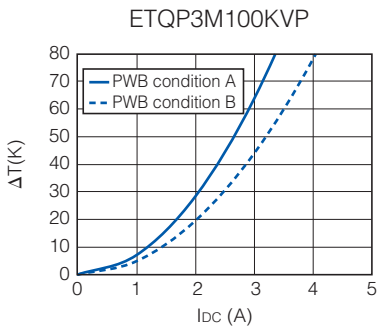

▲ Under development

2. Series PCC-M0630M-LP (ETQP3M□□□KVN)

Standard Parts

Series	Part No.	Inductance *1		DCR (at 20 °C) (mΩ)		Rated Current (Typ. : A)		
		L0 (μH)	Tolerance (%)	Typ. (max.)	Tolerance (%)	ΔT=40K		ΔL=-30%
						(*2)	(*3)	(*4)
PCC-M0630M-LP [6.5×6.0×3.0(mm)]	▲ETQP3M220KVN	22.00	±20	128 (140.8)	±10	2.2	2.7	4.3
	▲ETQP3M150KVN	15.00		99.2 (109.12)		2.5	3.0	5.1
	ETQP3M100KVN	10.00		71 (78.1)		2.9	3.6	6.1
	ETQP3M6R8KVN	6.80		45.6 (50.16)		3.6	4.5	8.1
	▲ETQP3M4R7KVN	4.70		29 (31.9)		4.6	5.6	9.8
	▲ETQP3M3R3KVN	3.30		24.1 (26.51)		5.0	6.1	11.5
	▲ETQP3M2R2KVN	2.20		14.5 (15.95)		6.5	7.9	12.8
	▲ETQP3M1R5KVN	1.50		11 (12.1)		7.4	9.1	14.2
	▲ETQP3M1R0KVN	1.00		6.2 (6.82)		9.9	12.1	16.0
	▲ETQP3MR68KVN	0.68		5.2 (5.72)		10.8	13.2	20.2

(*1) Measured at 100k Hz.

(*2) DC current which causes temperature rise of 40K. Parts are soldered by reflow on four-layer PWB (1.6 mm FR4) and measured at room temperature. See also (*5)

(*3) DC current which causes temperature rise of 40K. Parts are soldered by reflow on multilayer PWB with high heat dissipation performance. Note: Heat radiation constant are approx. 44 K/W measured on 6.5×6.0×3.0 mm case size. See also (*5)

(*4) Saturation rated current : DC current which causes L(0) drop -30 %.

(*5) Within a suitable application, the part's temperature depends on circuit design and certain heat dissipation conditions. This should be double checked in a worst case operation mode.

In normal case, the max.standard operating temperature of +155 °C should not be exceeded.

For higher operating temperature conditions, please contact Panasonic representative in your area.

▲ Under development (Start of mass production : the 1st half of 2017) Please contact us for customized part no.

Performance Characteristics (Reference)

● Inductance vs DC Current

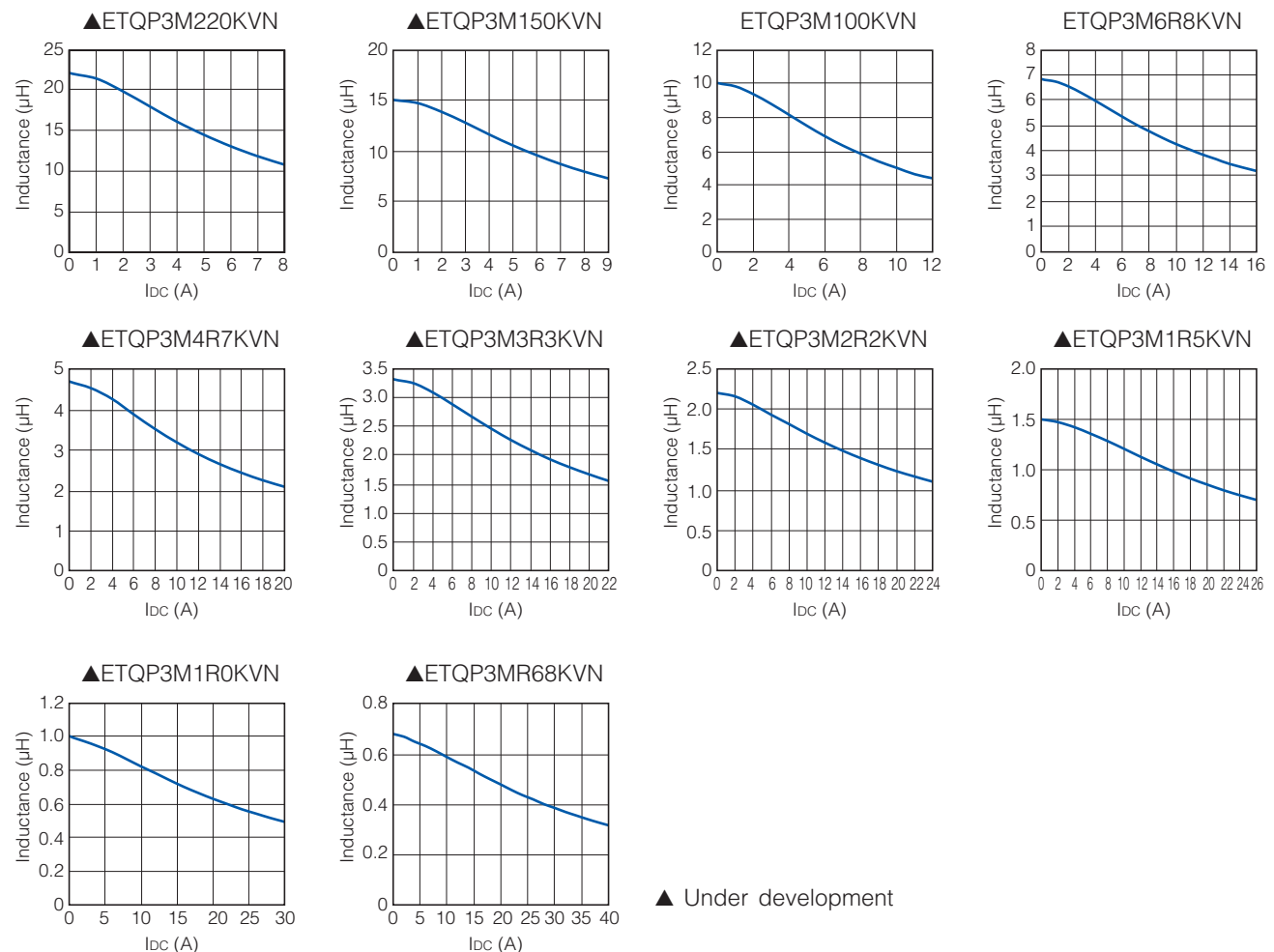

Performance Characteristics (Reference)

● Case Temperature vs DC Current

PWB condition A : Four-layer PWB (1.6 mm FR4), See also (*2)

PWB condition B : Multilayer PWB with high heat dissipation performance. See also (*3)

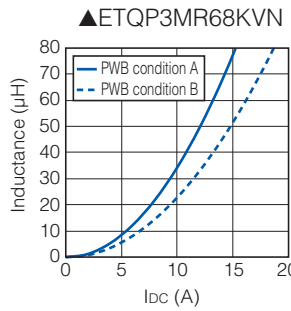
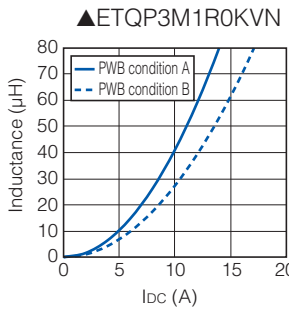
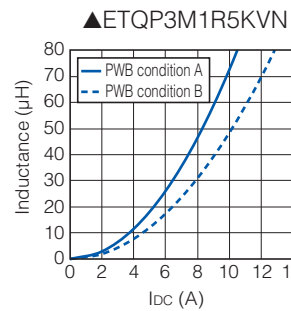
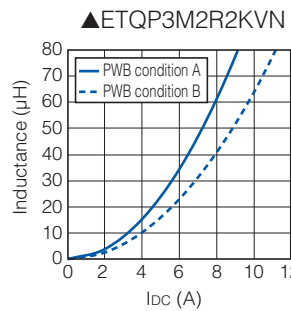
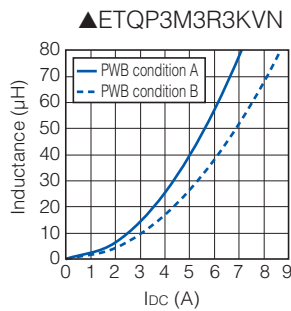
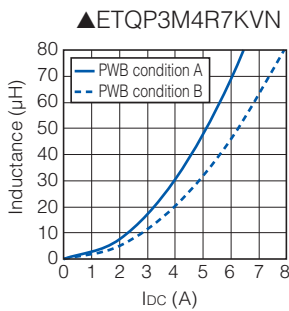
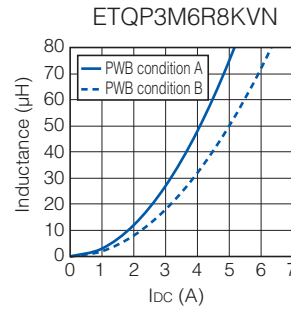
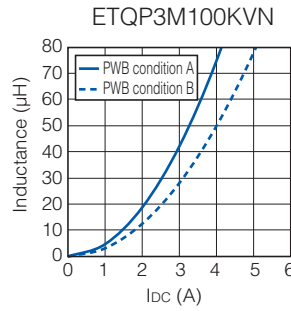
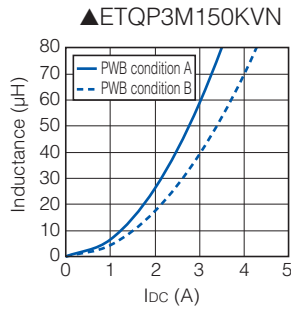
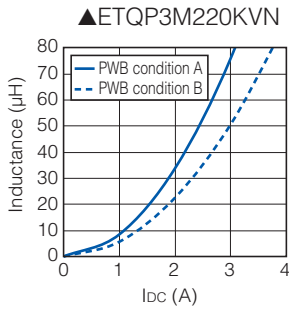

▲ Under development

3. Series PCC-M0840M-LP (ETQP4M□□□KVK)

Standard Parts

Series	Part No.	Inductance *1		DCR (at 20 °C) (mΩ)		Rated Current (Typ. : A)		
		L0 (μH)	Tolerance (%)	Typ. (max.)	Tolerance (%)	ΔT=40K		ΔL=-30%
						(*2)	(*3)	(*4)
PCC-M0840M-LP [8.5×8.0×4.0(mm)]	▲ETQP4M330KVK	33.00	±20	118 (129.8)	±10	2.6	3.1	5.3
	▲ETQP4M220KVK	22.00		76.3 (83.93)		3.3	3.8	6.7
	▲ETQP4M150KVK	15.00		55 (60.5)		3.8	4.5	7.7
	▲ETQP4M100KVK	10.00		41.6 (45.76)		4.4	5.2	9.1
	▲ETQP4M6R8KVK	6.80		23.5 (25.85)		5.9	6.9	11.0
	ETQP4M4R7KVK	4.70		16.1 (17.71)		7.1	8.3	15.1
	▲ETQP4M3R3KVK	3.30		14 (15.4)		7.6	8.9	17.4
	▲ETQP4M2R2KVK	2.20		8.5 (9.35)		9.8	11.4	20.4
	▲ETQP4M1R5KVK	1.50		4.9 (5.39)		12.8	15.1	22.5
	▲ETQP4M1R0KVK	1.00		3.7 (4.07)		14.8	17.3	24.4
▲ETQP4MR68KVK	0.68	2.9 (3.19)	16.7	19.6	29.0			

(*1) Measured at 100k Hz.

(*2) DC current which causes temperature rise of 40K. Parts are soldered by reflow on four-layer PWB (1.6 mm FR4) and measured at room temperature. See also (*5)

(*3) DC current which causes temperature rise of 40K. Parts are soldered by reflow on multilayer PWB with high heat dissipation performance. Note: Heat radiation constant are approx. 36 K/W measured on 8.5×8.0×4.0 mm case size. See also (*5)

(*4) Saturation rated current : DC current which causes L(0) drop -30 %.

(*5) Within a suitable application, the part's temperature depends on circuit design and certain heat dissipation conditions. This should be double checked in a worst case operation mode.

In normal case, the max.standard operating temperature of +155 °C should not be exceeded.

For higher operating temperature conditions, please contact Panasonic representative in your area.

▲ Under development (Start of mass production: the 2nd half of 2017) Please contact us for customized part no.

Performance Characteristics (Reference)

● Inductance vs DC Current

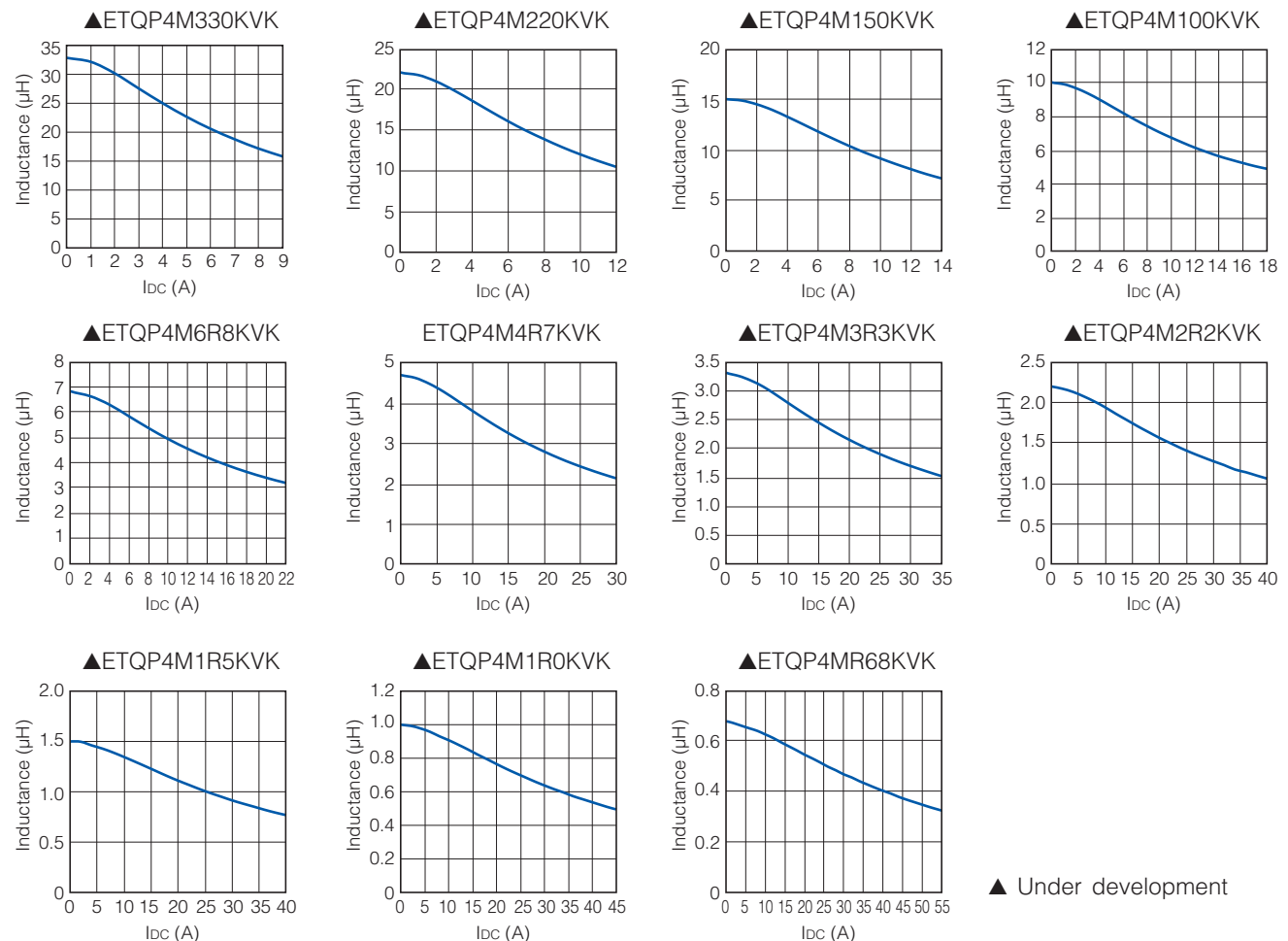

Performance Characteristics (Reference)

● Case Temperature vs DC Current

PWB condition A : Four-layer PWB (1.6 mm FR4), See also (*2)

PWB condition B : Multilayer PWB with high heat dissipation performance. See also (*3)

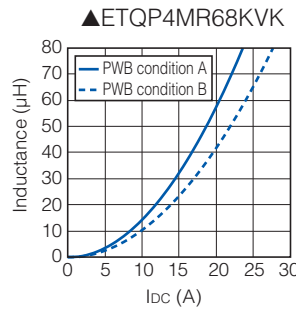
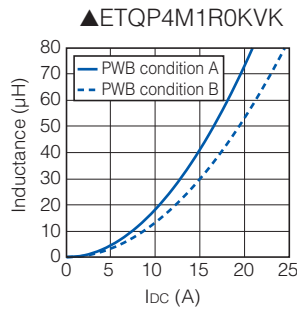
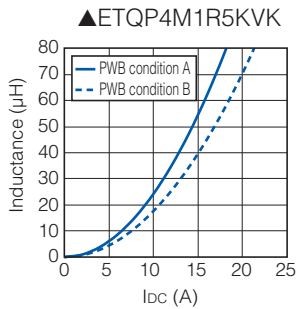
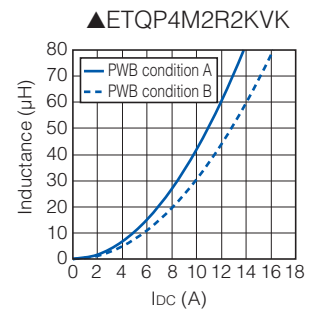
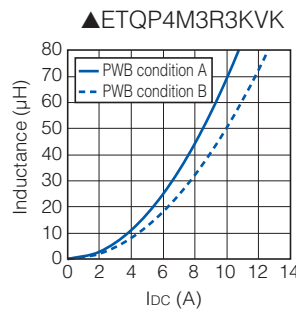
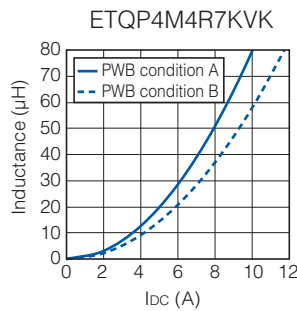
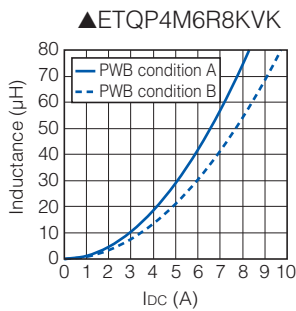
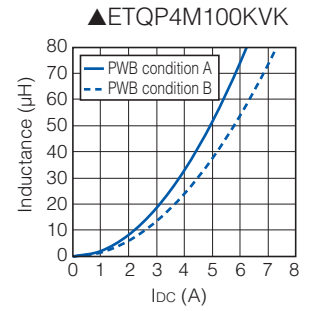
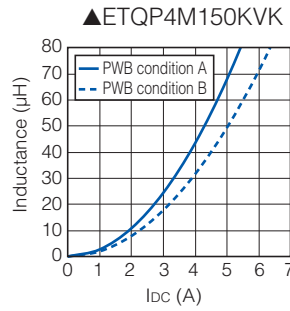
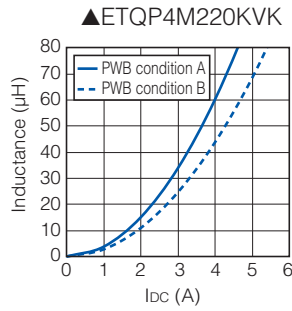
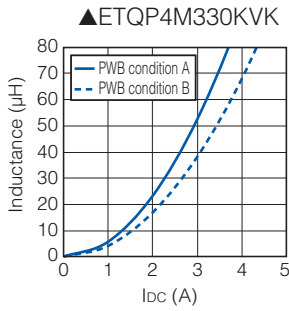

▲ Under development

4. Series PCC-M1040M-LP (ETQP4M□□□KVC)

Standard Parts

Series	Part No.	Inductance *1		DCR (at 20 °C) (mΩ)		Rated Current (Typ. : A)		
		L0 (μH)	Tolerance (%)	Typ. (max.)	Tolerance (%)	ΔT=40K		ΔL=-30%
						(*2)	(*3)	(*4)
PCC-M1040M-LP [10.7×10.0×4.0(mm)]	▲ETQP4M470KVC	47.00	±20	132 (145.2)	±10	2.8	3.4	4.7
	▲ETQP4M330KVC	33.00		84.6 (93.06)		3.4	4.2	5.6
	▲ETQP4M220KVC	22.00		60 (66)		4.1	5.0	7.4
	▲ETQP4M150KVC	15.00		37 (40.7)		5.2	6.3	9.2
	▲ETQP4M100KVC	10.00		25.4 (27.94)		6.3	7.6	10.8
	▲ETQP4M6R8KVC	6.80		18.5 (20.35)		7.4	8.9	12.1
	▲ETQP4M4R7KVC	4.70		11.8 (12.98)		9.2	11.2	13.9
	▲ETQP4M3R3KVC	3.30		9.4 (10.34)		10.3	12.6	17.1
	▲ETQP4M2R2KVC	2.20		6.8 (7.48)		12.1	14.8	21.0
	▲ETQP4M1R5KVC	1.50		4.9 (5.39)		14.3	17.4	25.0
▲ETQP4M1R0KVC	1.00	2.6 (2.86)	19.6	23.9	34.6			

(*1) Measured at 100k Hz.

(*2) DC current which causes temperature rise of 40K. Parts are soldered by reflow on four-layer PWB (1.6 mm FR4) and measured at room temperature. See also (*5)

(*3) DC current which causes temperature rise of 40K. Parts are soldered by reflow on multilayer PWB with high heat dissipation performance. Note: Heat radiation constant are approx. 27 K/W measured on 10.7×10.0×4.0 mm case size. See also (*5)

(*4) Saturation rated current : DC current which causes L(0) drop -30 %.

(*5) Within a suitable application, the part's temperature depends on circuit design and certain heat dissipation conditions. This should be double checked in a worst case operation mode.

In normal case, the max.standard operating temperature of +155 °C should not be exceeded.

For higher operating temperature conditions, please contact Panasonic representative in your area.

▲ Under development (Start of mass production: the 2nd half of 2017) Please contact us for customized part no.

Performance Characteristics (Reference)

● Inductance vs DC Current

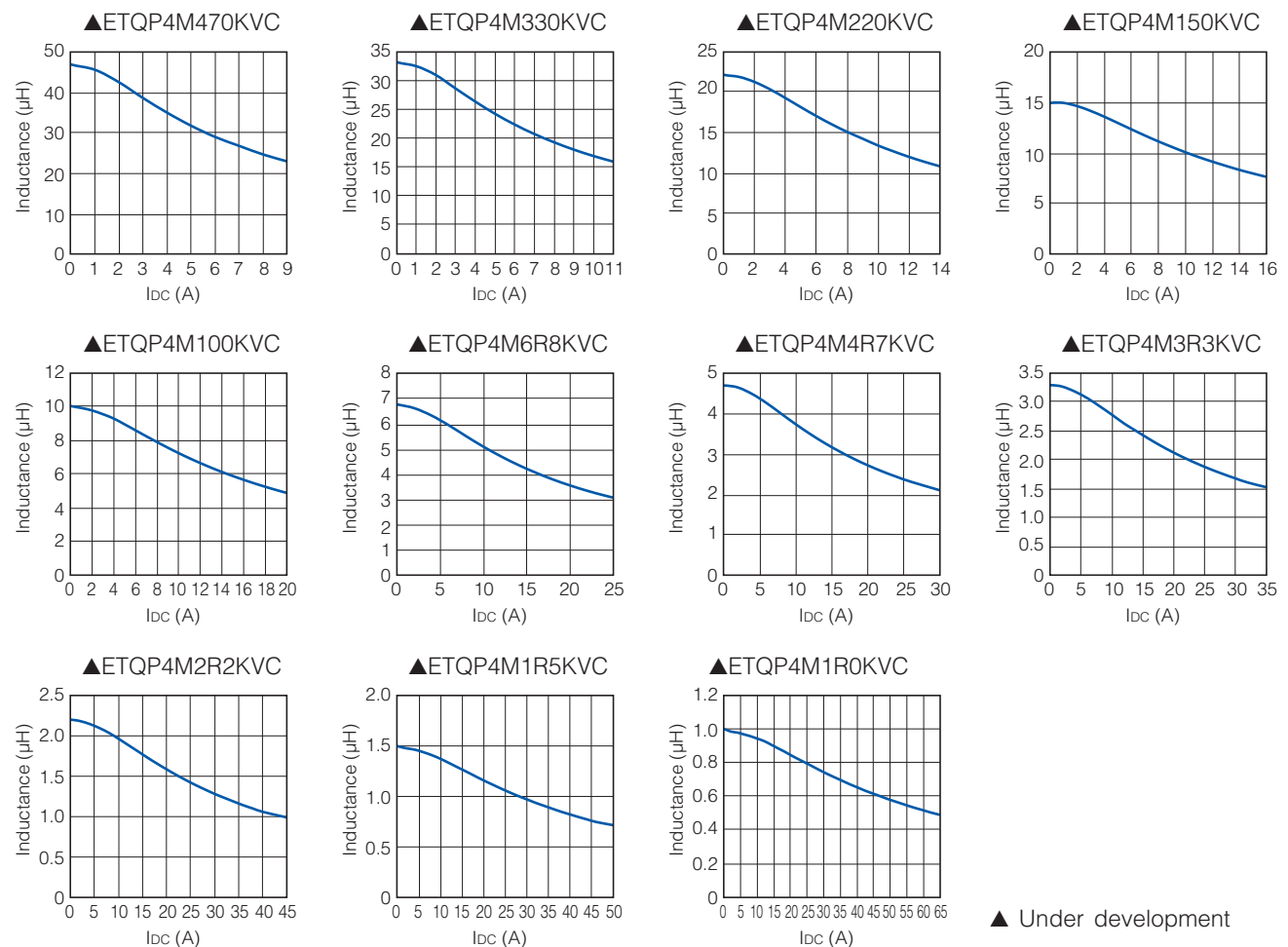

Performance Characteristics (Reference)

● Case Temperature vs DC Current

PWB condition A : Four-layer PWB (1.6 mm FR4), See also (*2)

PWB condition B : Multilayer PWB with high heat dissipation performance. See also (*3)

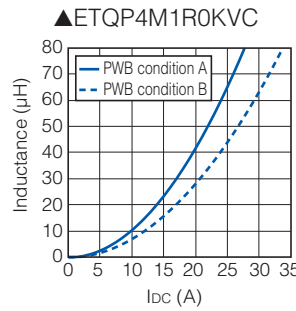
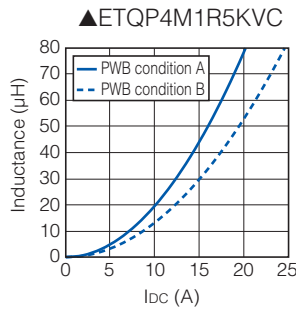
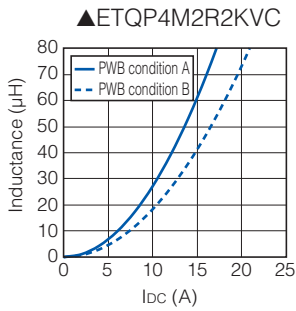
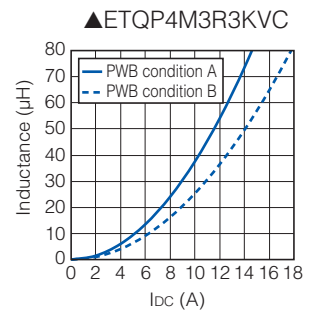
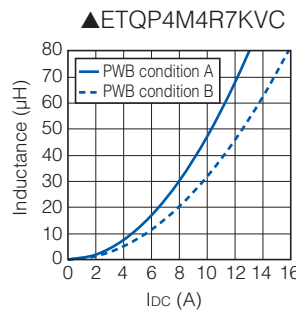
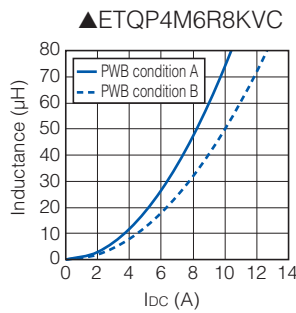
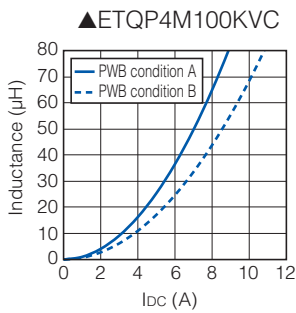
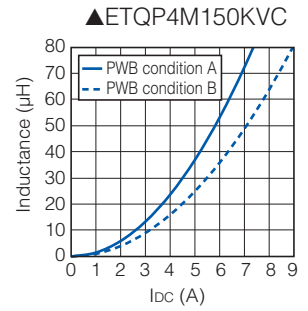
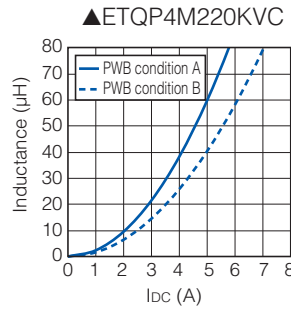
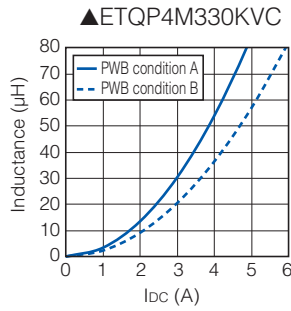
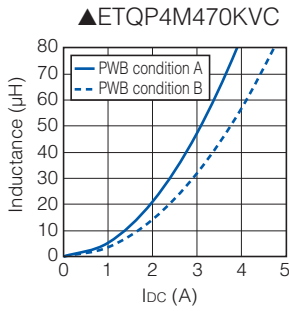

▲ Under development

Dimensions in mm (not to scale)

Dimensional tolerance unless noted : ± 0.5

Series PCC-M0530M-LP
(ETQP3M□□□KVP)

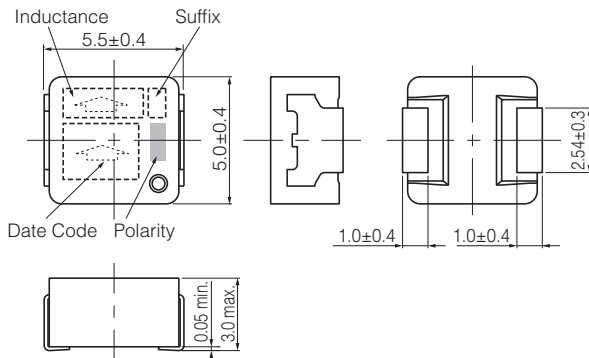

Series PCC-M0630M-LP
(ETQP3M□□□KVN)

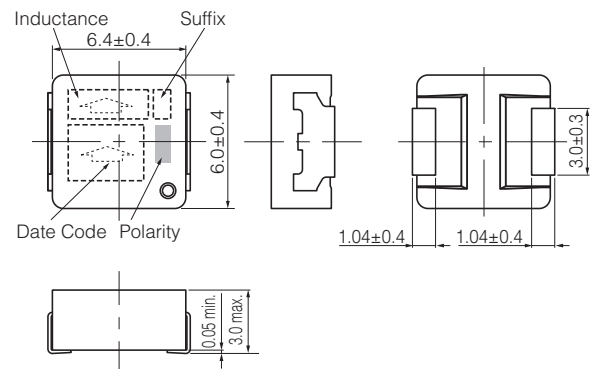

Series PCC-M0840M-LP
(ETQP4M□□□KVK)

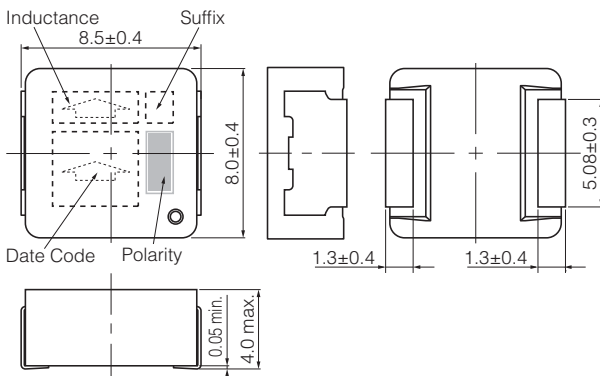

Series PCC-M1040M-LP
(ETQP4M□□□*KVC)
* Exemption "1R0"

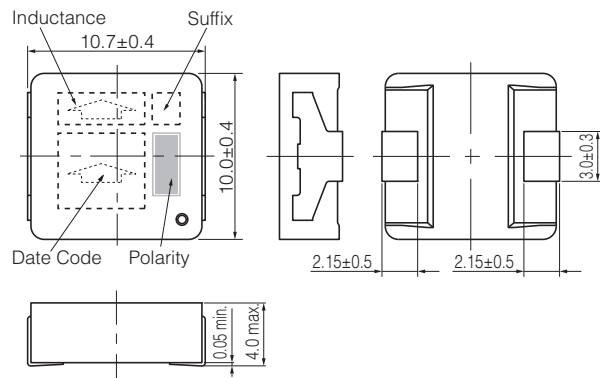

Series PCC-M1040M-LP
(ETQP4M1R0KVC)

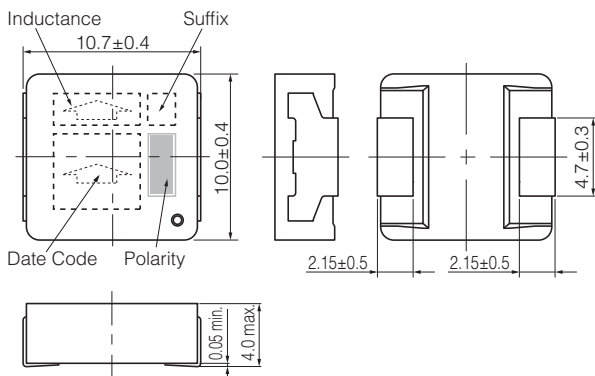

Recommended Land Pattern in mm (not to scale)

Dimensional tolerance unless noted : ± 0.5

Series PCC-M0530M-LP
(ETQP3M□□□KVP)



Don't wire on the pattern on shaded portion the PWB.

Series PCC-M0630M-LP
(ETQP3M□□□KVN)

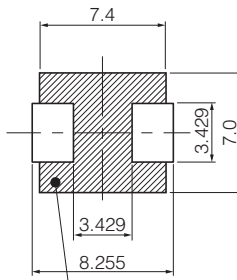

The same as the left.

Series PCC-M0840M-LP
(ETQP4M□□□KVK)

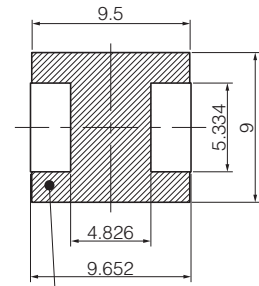

The same as the left.

Series PCC-M1040M-LP
(ETQP4M□□□*KVC)
* Exemption "1R0"

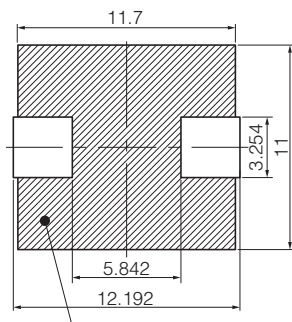

Don't wire on the pattern on shaded portion the PWB.

Series PCC-M1040M-LP
(ETQP4M1R0KVC)

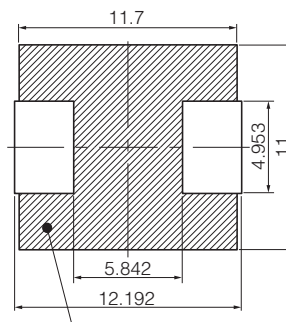

The same as the left.

■ As for Soldering Conditions and Safety Precautions (Power Choke Coils for Automotive application),

Please see Data Files

Packaging Methods (Taping)

- Embossed Carrier Tape Dimensions in mm (not to scale)

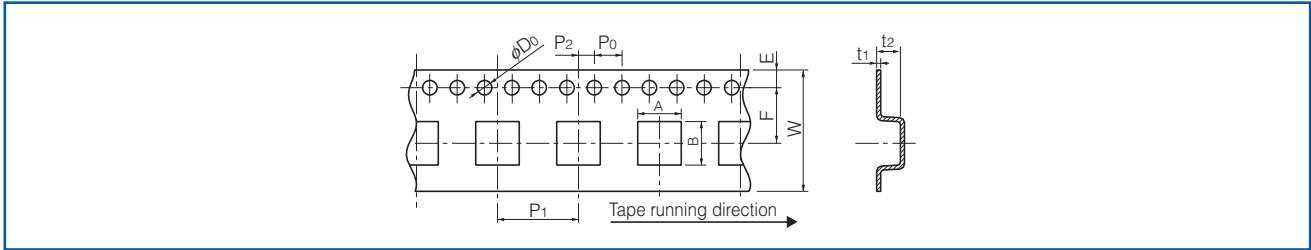

Series	A	B	W	E	F	P ₁	P ₂	P ₀	φD ₀	t ₁	t ₂
PCC-M0530M-LP	5.6	6.1	16	1.75	7.5	8	2	4	1.5	0.3	3.3
PCC-M0630M-LP	6.5	7.1	16	1.75	7.5	8	2	4	1.5	0.3	3.3
PCC-M0840M-LP	8.63	9.1	16	1.75	7.5	12	2	4	1.5	0.4	6.0
PCC-M1040M-LP	10.65	11.75	24	1.75	11.5	16	2	4	1.5	0.5	6.35

- Taping Reel Dimensions in mm (not to scale)

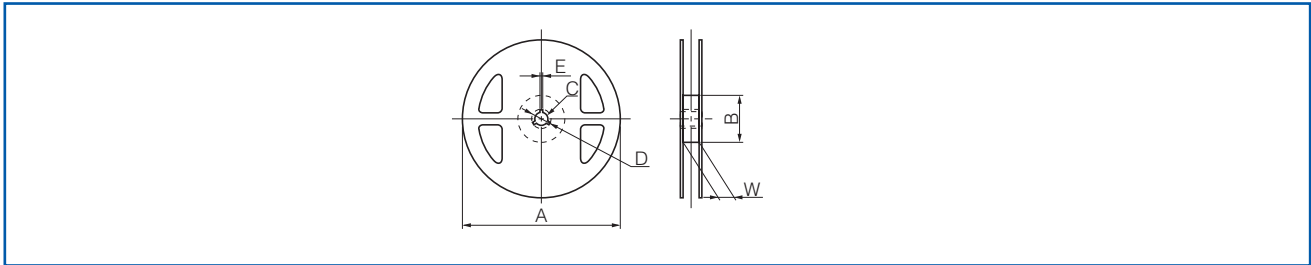

Series	A	B	C	D	E	W
PCC-M0530M-LP PCC-M0630M-LP PCC-M0840M-LP	330	(100)	13	21	2	17.5
PCC-M1040M-LP						25.5

Component Placement (Taping)

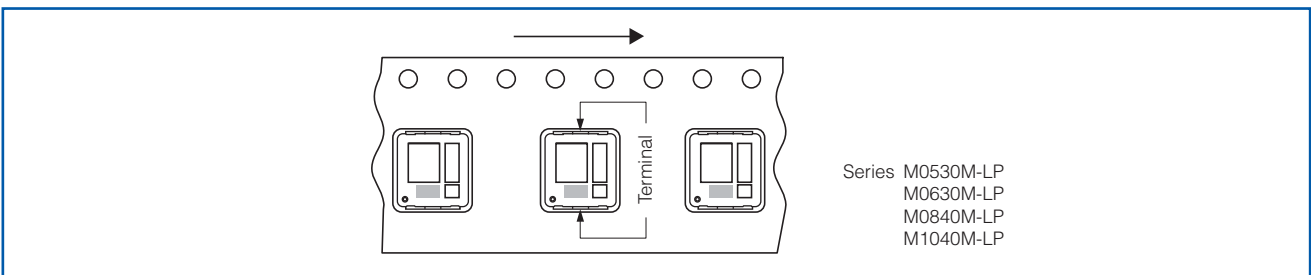

Standard Packing Quantity/Reel

Series	Part No.	Minimum Quantity / Packing Unit	Quantity per reel
PCC-M0530M-LP	ETQP3M□□□KVP	4,000 pcs. / box (2 reel)	2,000 pcs.
PCC-M0630M-LP	ETQP3M□□□KVN	4,000 pcs. / box (2 reel)	2,000 pcs.
PCC-M0840M-LP	ETQP4M□□□KVK	1,000 pcs. / box (2 reel)	500 pcs.
PCC-M1040M-LP	ETQP4M□□□KVC	1,000 pcs. / box (2 reel)	500 pcs.