

4

3

2

1

THIS DRAWING IS UNPUBLISHED. RELEASED FOR PUBLICATION
BY TYCO ELECTRONICS CORPORATION. ALL RIGHTS RESERVED.

LOC	DIST	REVISIONS					
ES	-	P	LT	DESCRIPTION	DATE	DWN	APVD
		0		RELEASED FB00-0074-04	22APR04	J.J.	J.O.

MINIMUM AVAILABLE AREA FOR PICK AND PLACE
VACUUM PICK-UP
9.7 x 4.4 mm
FREE FROM BURRS, SCRATCHES OR MARKS.

SCALE 3:1

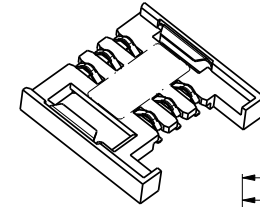

PCB Layout

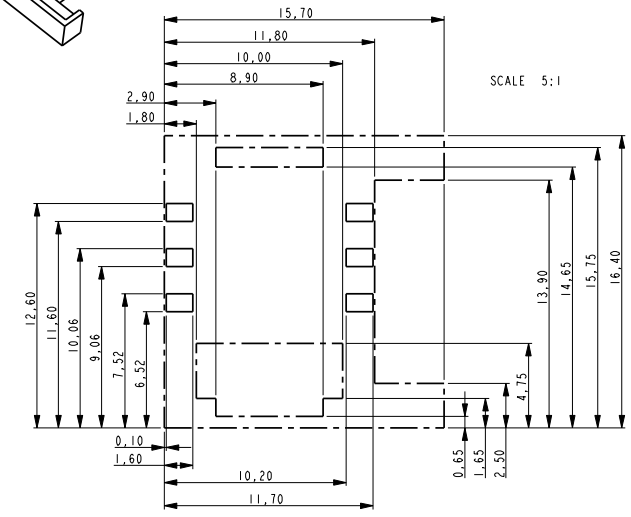

SCALE 5:1

NOTES:

- Contact spring plated completely 1,5 ... 1,8 Um Ni
- △ -In this zone completely plated min 3 Um Sn
- △ -In this zone plated min 0,2 Um Au over min 1 Um Pd or PdNi)
- △ -This area not concave
- a) When contact is compressed to this height, spring force min 0,3 N. - 0,7 N
- b) Highest point of contact always below highest point of housing
- △ -Overall dimension
- △ Coplanarity measured over 6 contacts in one pass

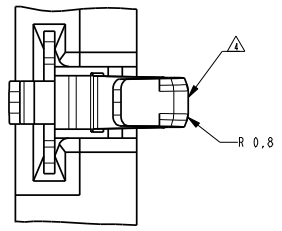
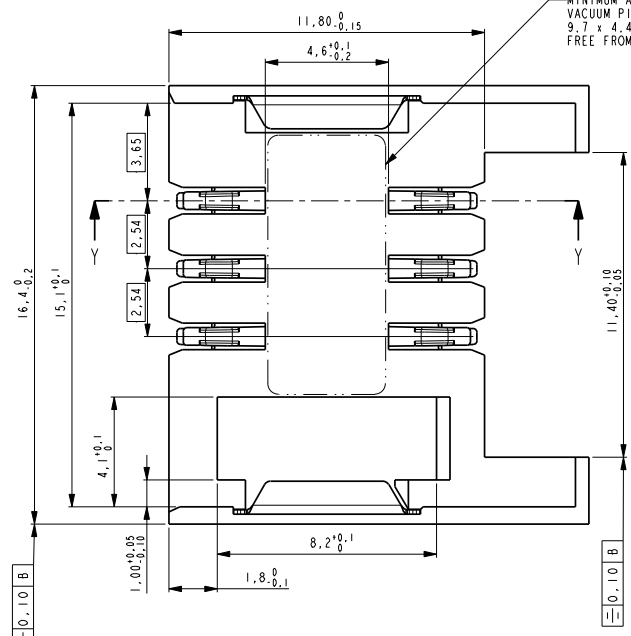
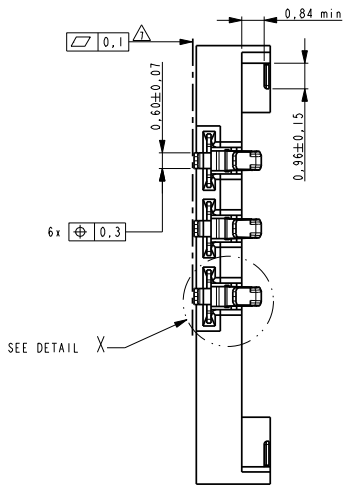

DETAIL X
SCALE 20:1

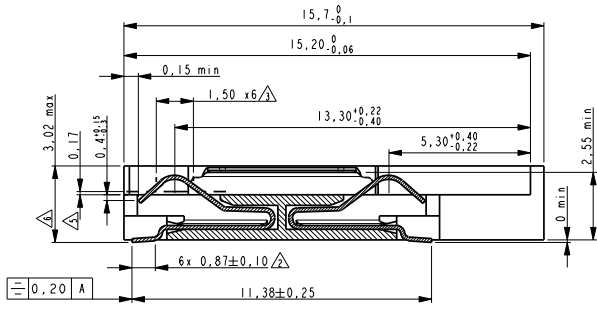

SECTION Y-Y

<small>THIS DRAWING IS UNPUBLISHED. RELEASED FOR PUBLICATION BY TYCO ELECTRONICS CORPORATION. ALL RIGHTS RESERVED.</small>		DWN J. JIANG	16APR04	Tyco Electronics Corporation Shanghai, P.R.China, 200233
<small>IF THIS DRAWING IS TO BE USED FOR THE CONSTRUCTION OF A PART, THE DIMENSIONS AND TOLERANCES SPECIFIED HEREIN SHOULD BE CONTACTED FOR THE LATEST REVISION.</small>		CHK S. YAO	16APR04	
<small>TOLERANCES UNLESS OTHERWISE SPECIFIED:</small>		APVD L. QIU	16APR04	
<small>0 PLC ±</small> <small>1 PLC ±</small> <small>2 PLC ±</small> <small>3 PLC ±</small> <small>4 PLC ±</small> <small>ANGLES ±</small> <small>MATERIAL -</small> <small>FINISH -</small>		NAME	SLIDING SIM CONNECTOR	
<small>PRODUCT SPEC</small> <small>APPLICATION SPEC</small> <small>WEIGHT</small>		SIZE	A2	<small>CAGE CODE</small> 00779
<small>CUSTOMER DRAWING</small>		<small>DRAWING NO</small> 6393699	<small>RESTRICTED TO</small> -	<small>SCALE</small> 2:1.5
		<small>SHEET</small> 1 of 2		<small>REV</small> 0

4

3

2

1

THIS DRAWING IS UNPUBLISHED. RELEASED FOR PUBLICATION
COPYRIGHT BY TYCO ELECTRONICS CORPORATION. ALL RIGHTS RESERVED.

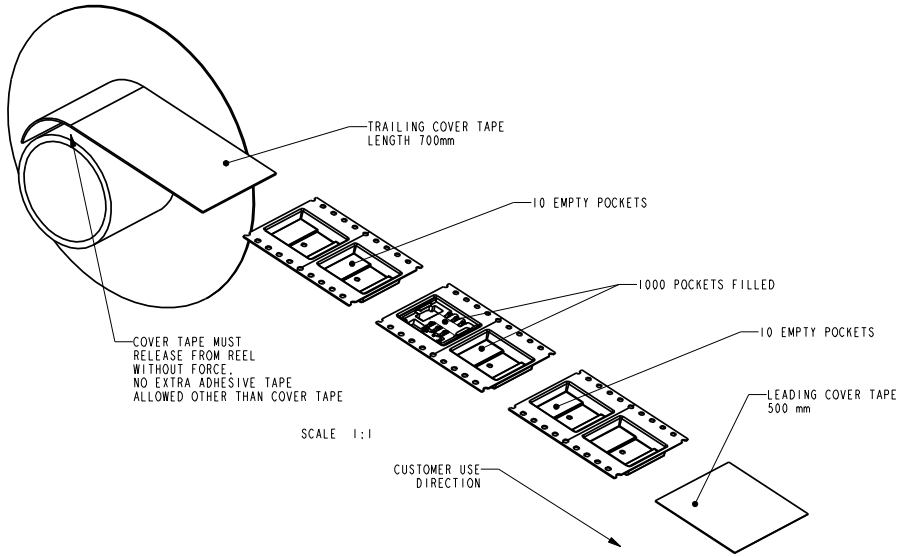

6393699-1

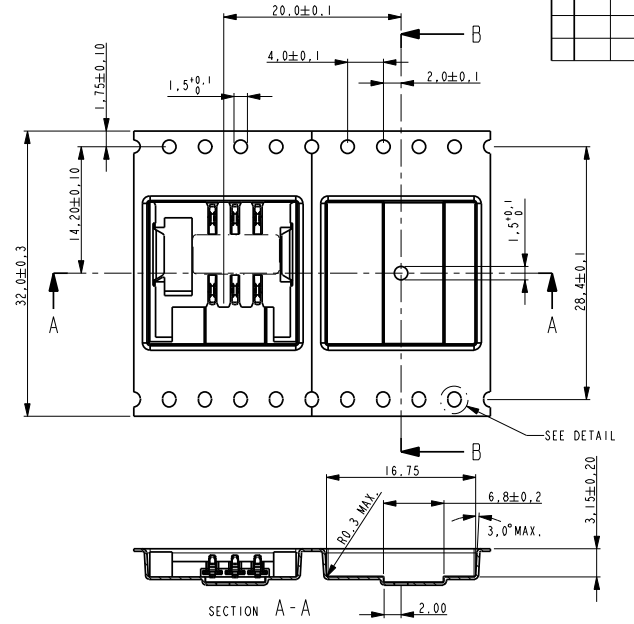

LOC	DIST	REVISIONS					
ES	-	P	LTR	DESCRIPTION	DATE	DWN	APVD
		-		SEE SHEET 1			

6393699-2

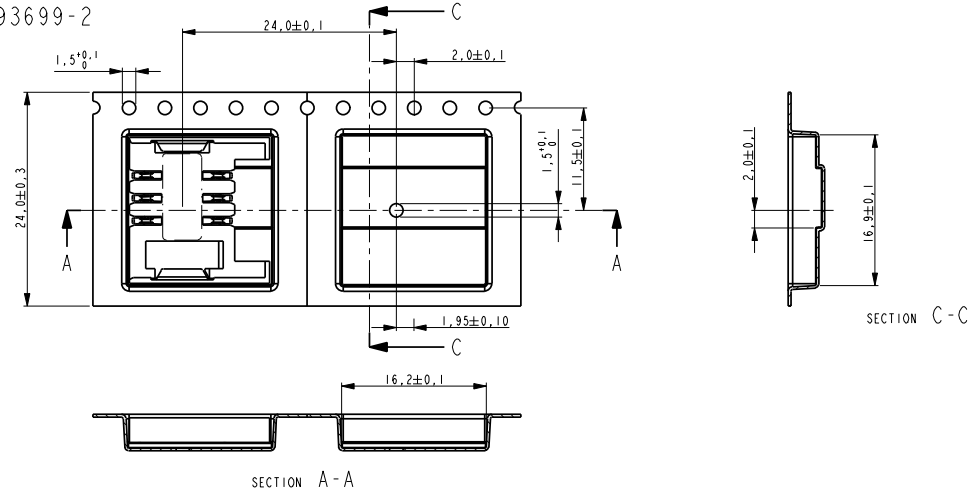

NOTES:

△ PACKAGING: TAPE MATERIAL PS BLACK CONDUCTIVE
OTHER FEATURES ACCORDING EIA 481-B

DIMENSIONS: mm		TOLERANCES UNLESS OTHERWISE SPECIFIED:		DWN J. JIANG 16APR04	Tyco Electronics Corporation Shanghai, P.R.China, 200233
		0 PLC ± 1 PLC ± 2 PLC ± 3 PLC ± 4 PLC ± ANGLES ± FINISH -		CHK S. YAO 16APR04	
MATERIAL -				APVD L. QIU 16APR04	NAME
				PRODUCT SPEC	SLIDING SIM CONNECTOR
				APPLICATION SPEC	
				WEIGHT -	SIZE
				CUSTOMER DRAWING	CAGE CODE DRAWING NO
					A2 00779 6393699
					RESTRICTED TO
					SCALE 2:1.5 SHEET 2 OF 2 REV 0