

BR-1632

DIMENSIONS (MM)

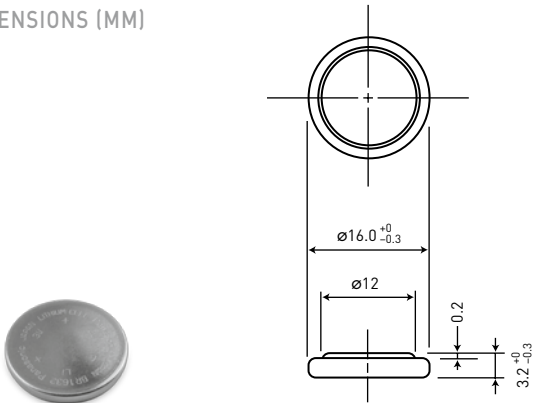

Model number	BR-1632
Nominal voltage (V)	3
Nominal capacity (mAh)	120
Diameter (mm)	16.0
Total height (mm)	3.2
Discharging temperature range (°C)	-30 to +80
Weight (g)	1.5

DISCHARGE TEMPERATURE CHARACTERISTICS

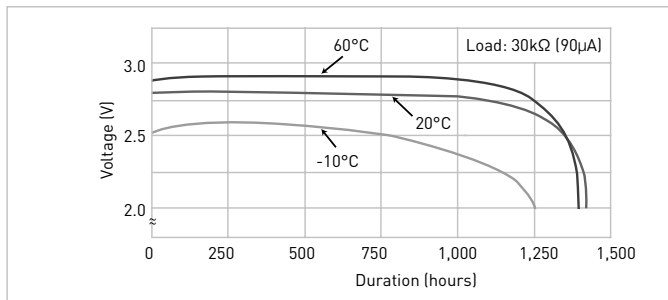

OPERATING VOLTAGE VS. DISCHARGE CURRENT*1

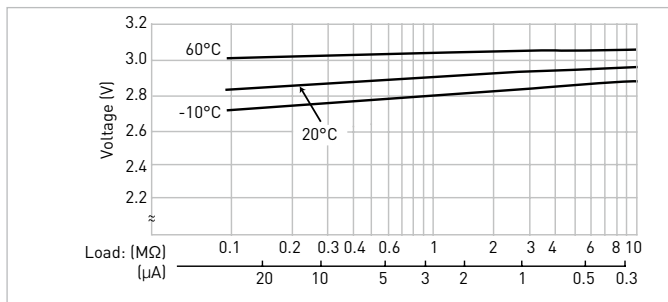

CAPACITY VS. LOAD RESISTANCE

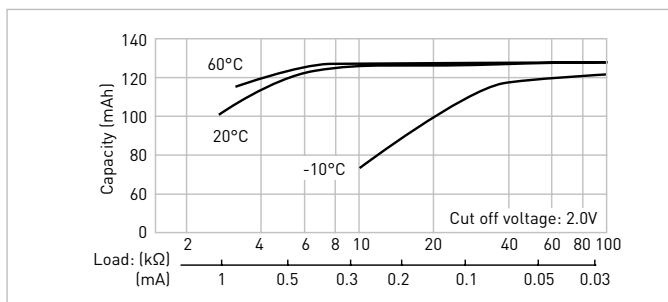

BR-2032

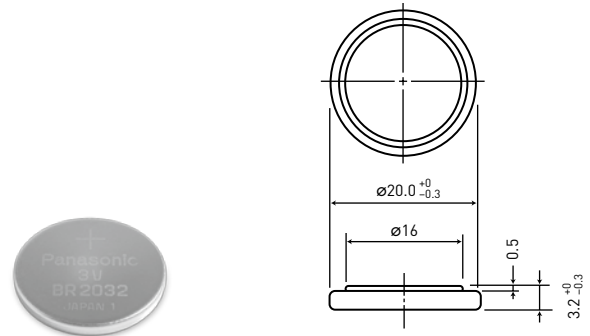

Model number	BR-2032
Nominal voltage (V)	3
Nominal capacity (mAh)	200
Diameter (mm)	20.0
Total height (mm)	3.2
Discharging temperature range (°C)	-30 to +80
Weight (g)	2.5

DISCHARGE TEMPERATURE CHARACTERISTICS

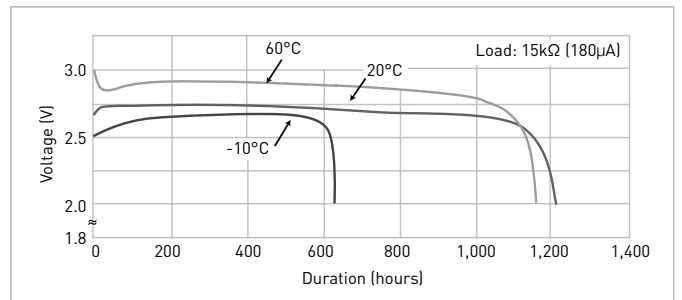

OPERATING VOLTAGE VS. DISCHARGE CURRENT*1

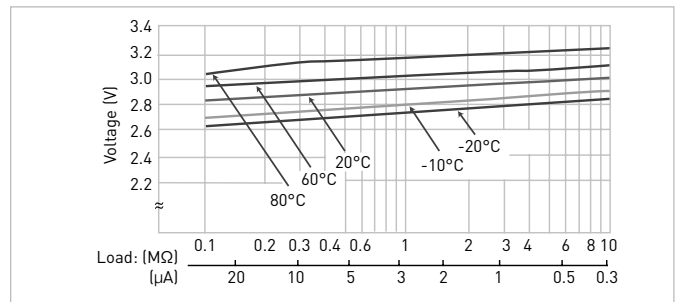

CAPACITY VS. LOAD RESISTANCE

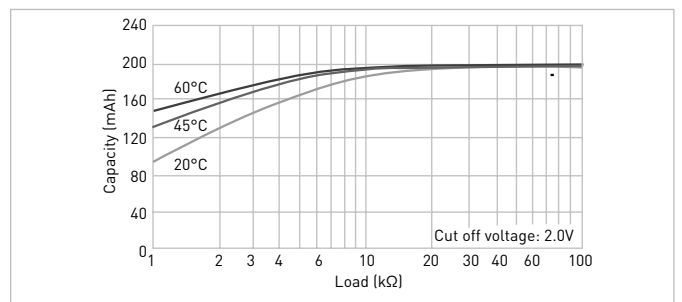

The data in this document are for descriptive purposes only and are not intended to make or imply any guarantee or warranty.
*1 Voltage at 50% discharge depth.